

Cod. 015143 GOLETTA	
Cod. 015043 GOLETTA INOX	
LEGNOLANDIA	Rev. 1

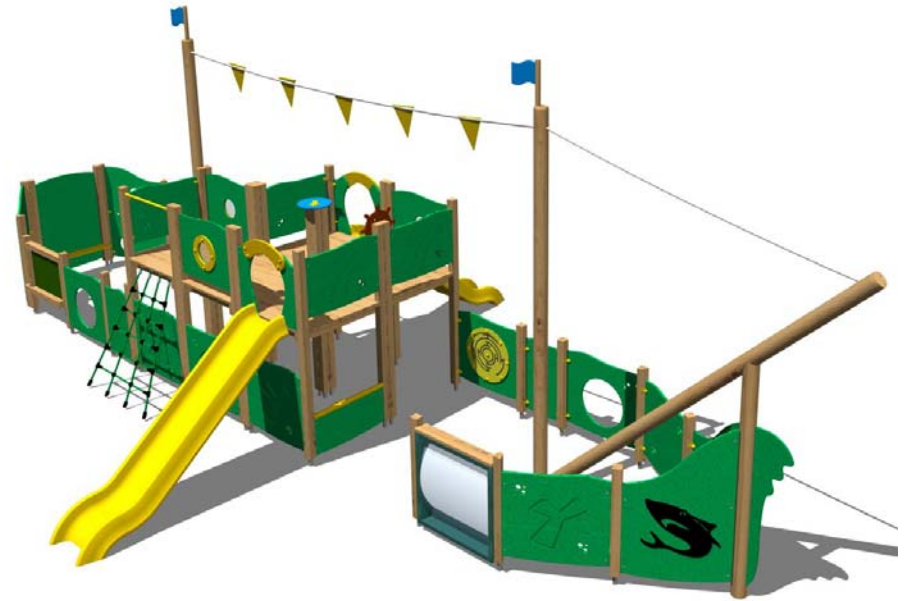

art. 015043



art. 015143



Cod. 015143 GOLETTA	
Cod. 015043 GOLETTA INOX	
LEGNOLANDIA	Rev. 1

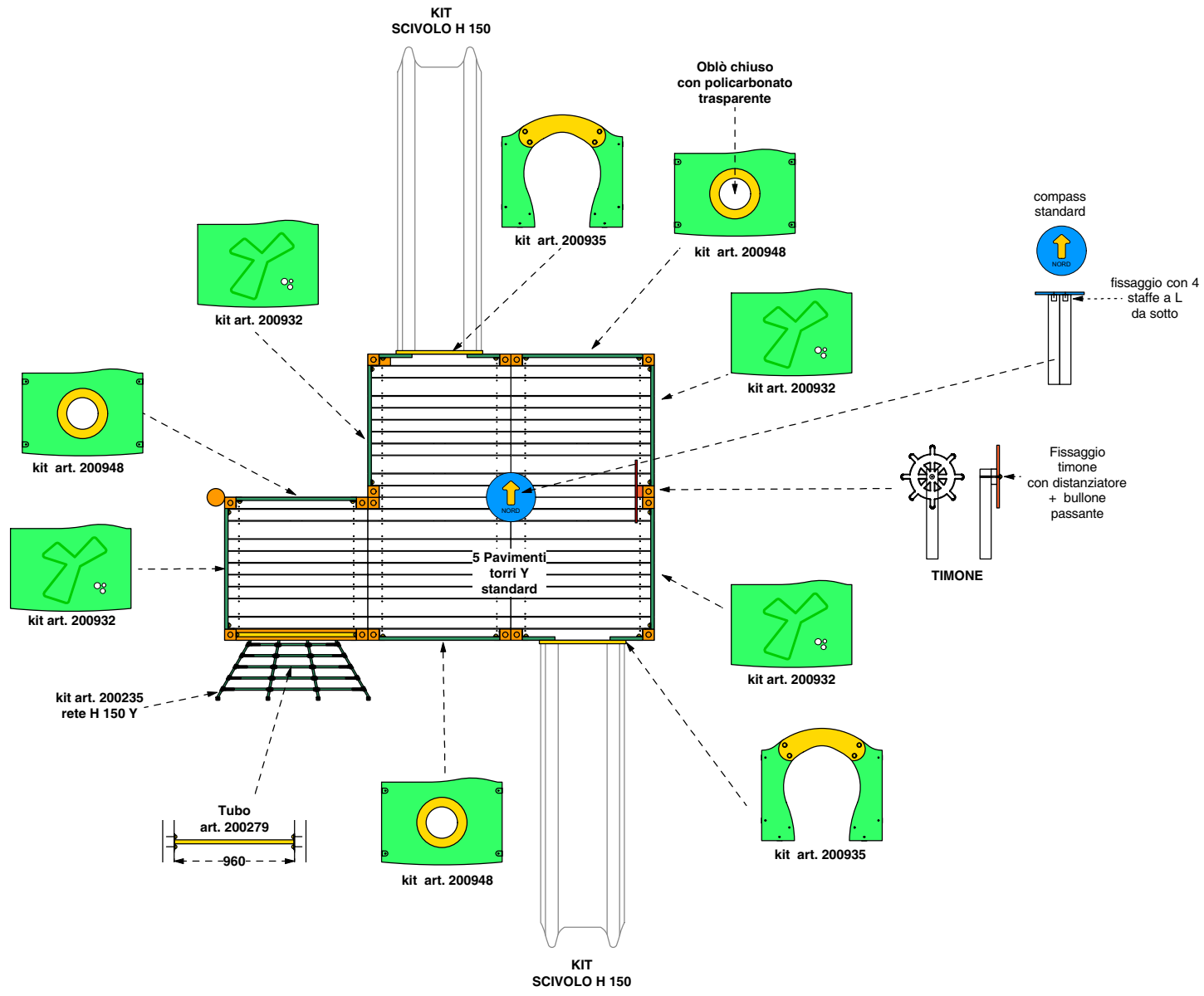

Cod. 015143 GOLETTA	
Cod. 015043 GOLETTA INOX	
LEGNOLANDIA	Rev. 1

PARTICOLARI PARETI

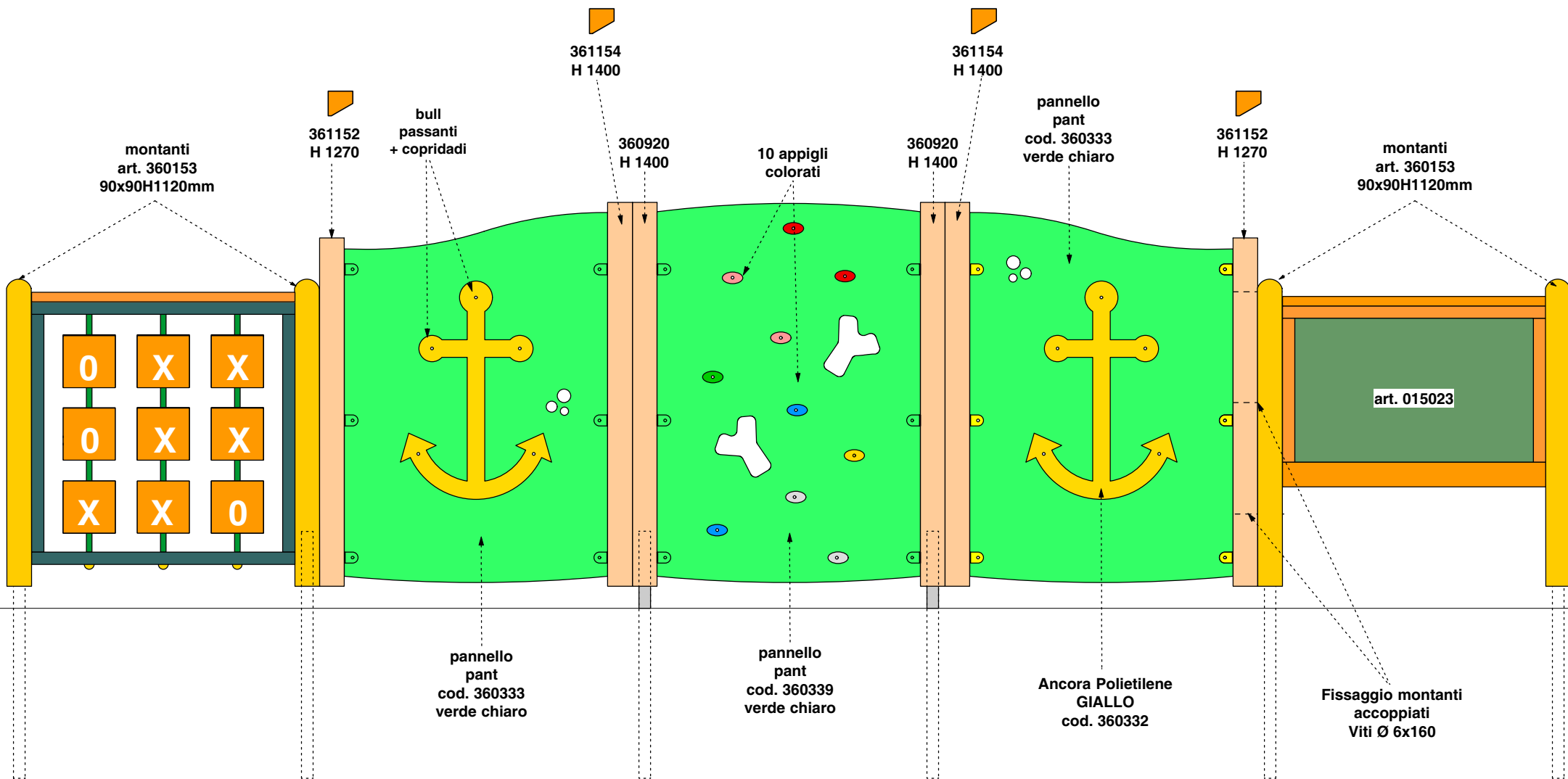

Cod. 015143 GOLETTA	
Cod. 015043 GOLETTA INOX	
LEGNOLANDIA	Rev. 1

PARTICOLARI PARETI

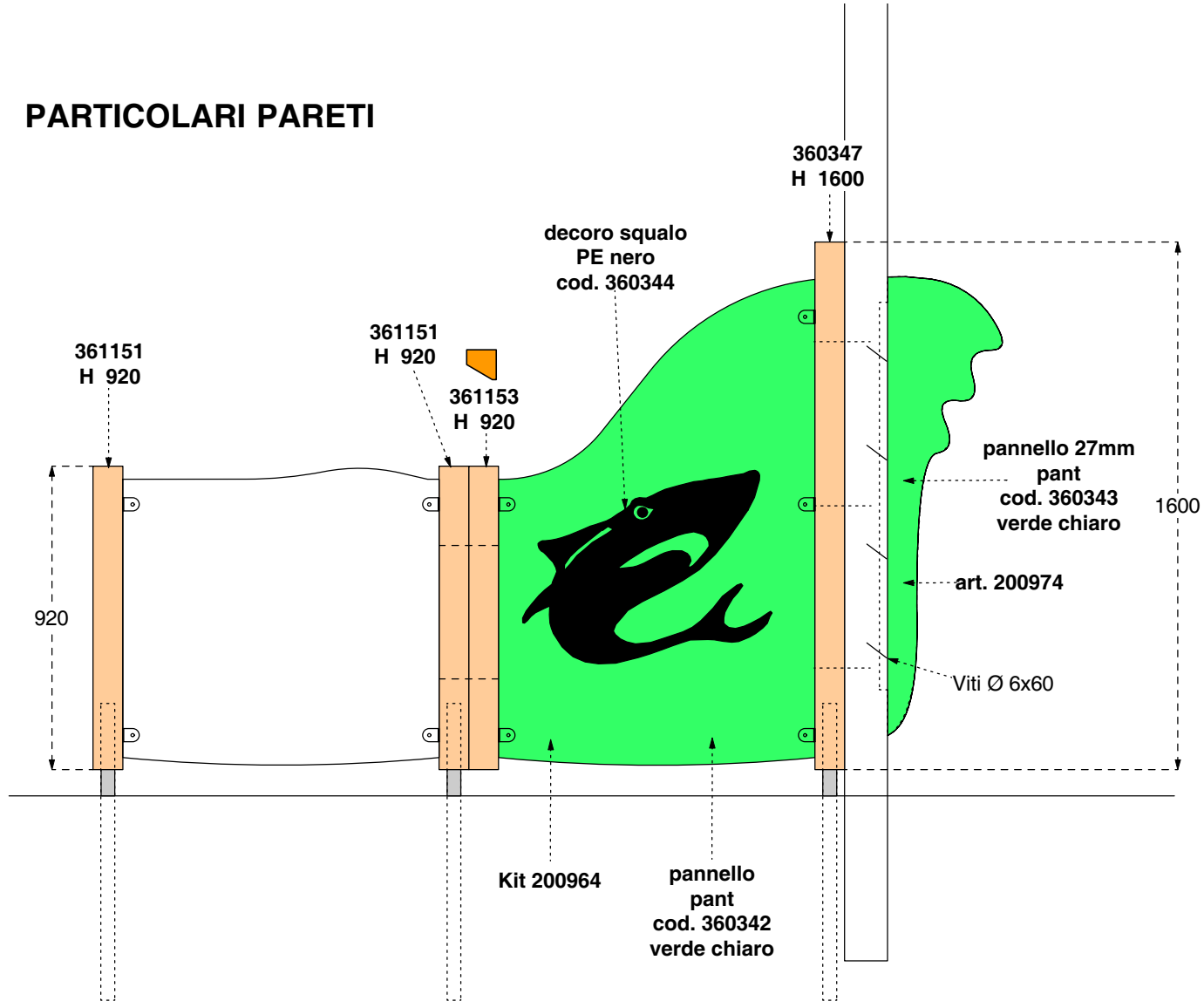

Cod. 015143 GOLETTA	
Cod. 015043 GOLETTA INOX	
LEGNOLANDIA	Rev. 1

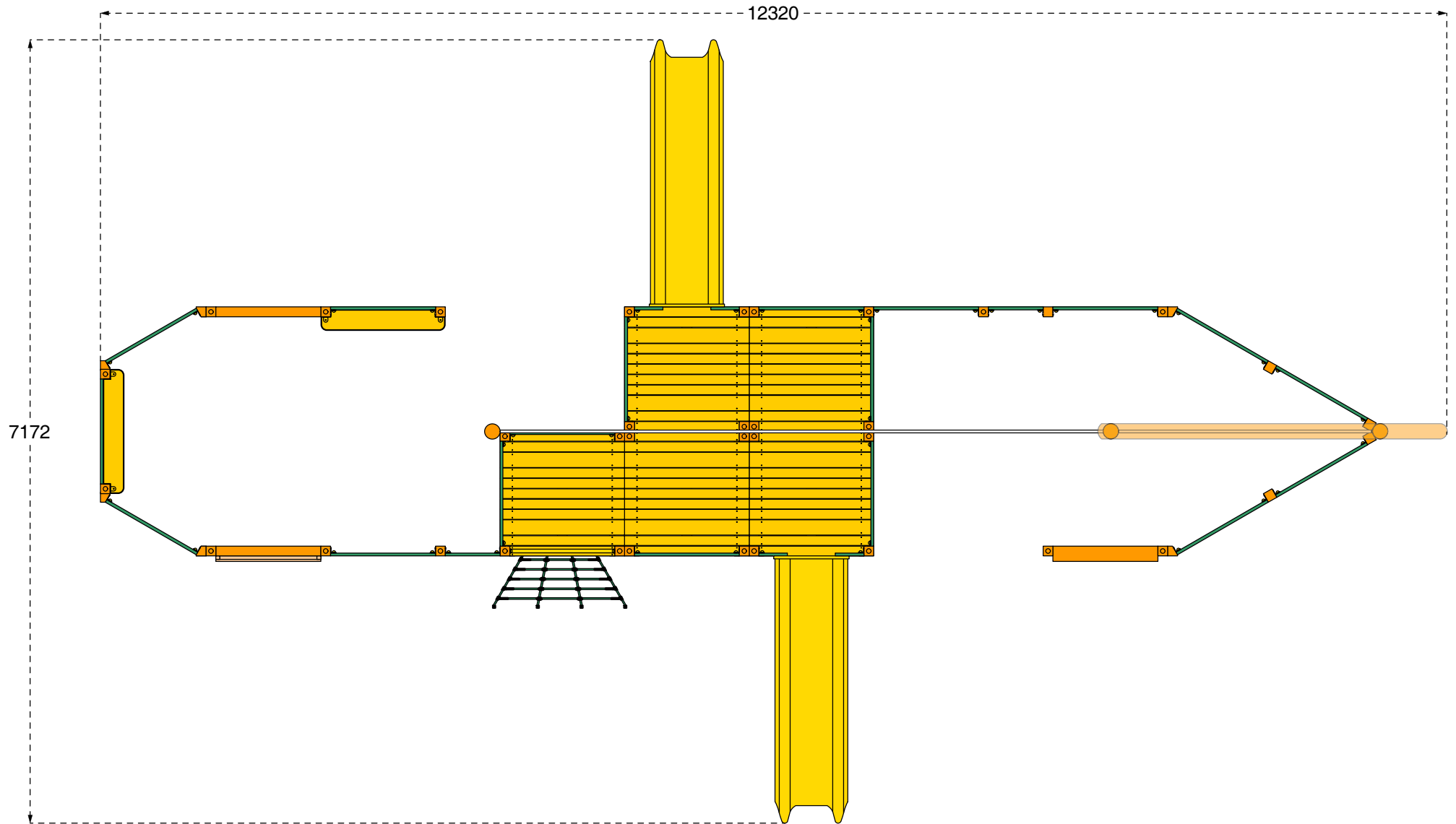

Cod. 015143 GOLETTA	
Cod. 015043 GOLETTA INOX	
LEGNOLANDIA	Rev. 1

ALBERI E FUNI

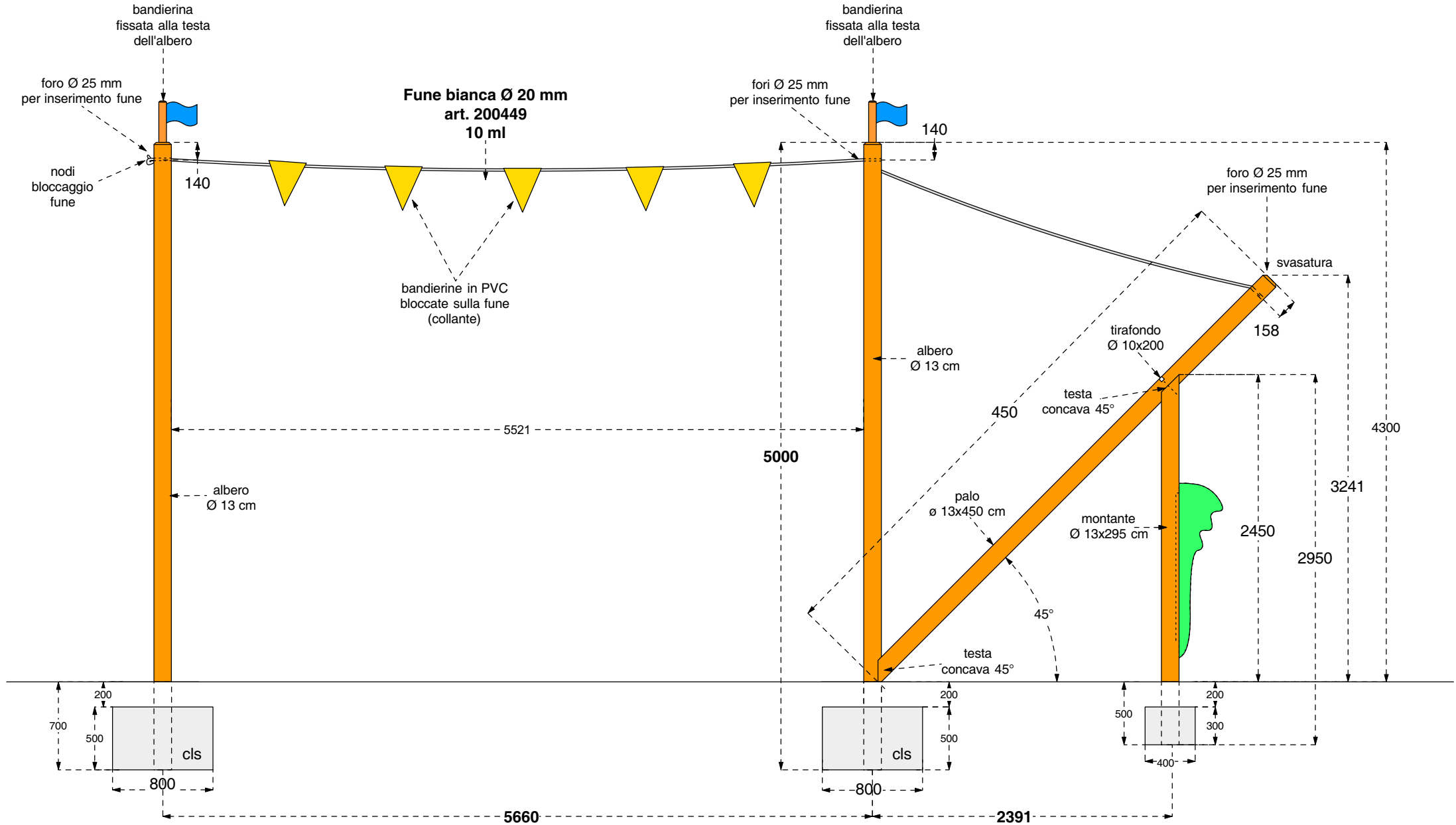

Cod. 015143 GOLETTA	
Cod. 015043 GOLETTA INOX	
LEGNOLANDIA	Rev. 1

DATI DI SICUREZZA / SAFETY DATA		EN 1176 - EN 1177
art. 015143 - 015043		
ALTEZZA DI CADUTA LIBERA max (HIC) / FALL HEIGHT (HIC)		150 cm
SPAZIO DI CADUTA / FALL SPACE		85,0 mq
PAVIMENTAZIONE IN PIASTRE ELASTICHE / ELASTIC TILES PAVEMENT		98,0 mq
ETA' USO CONSIGLIATA / RECOMMENDED AGE		da 3 a 14 anni
Per la manutenzione consultare l'apposita scheda fornita col gioco		
For maintenance see instructions supplied with the game		

**PAVIMENTAZIONI DI SICUREZZA
SAFETY PAVEMENT**

Su tutte le attrezzature per aree da gioco con un'altezza di caduta libera superiore a 60 cm bisogna prevedere il rivestimento dello spazio di caduta con una superficie ammortizzante.

On all playground equipment with a free fall height superior to 60 cm a surface cushioning has to be provided which covers the fall area.

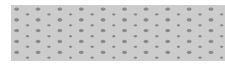
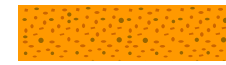
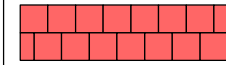
 PRATO e TERRICCIO / LAWN and GROUND Altezza di caduta / Fall height <math><= 100</math> cm	 SABBIA pezzatura / SAND size 0,2-2 mm GHIAIA pezzatura / GRAVEL size 2-8 mm Spessore minimo / Thickness 30 cm Altezza di caduta fino a / Fall Height up to 300 cm	 CORTECCIA pezzatura / BARK size 20-80 mm TRUCIOLI pezzatura / CHIPS size 5-30 mm Spessore minimo / Thickness 30 cm Altezza di caduta fino a / Fall Height up to 300 cm	 PIASTRE ELASTICHE / ELASTIC TILES
--	---	--	---

