

Cod. 015048 STEGOSAURUS POLY  
LEGNOLANDIA Rev. 4

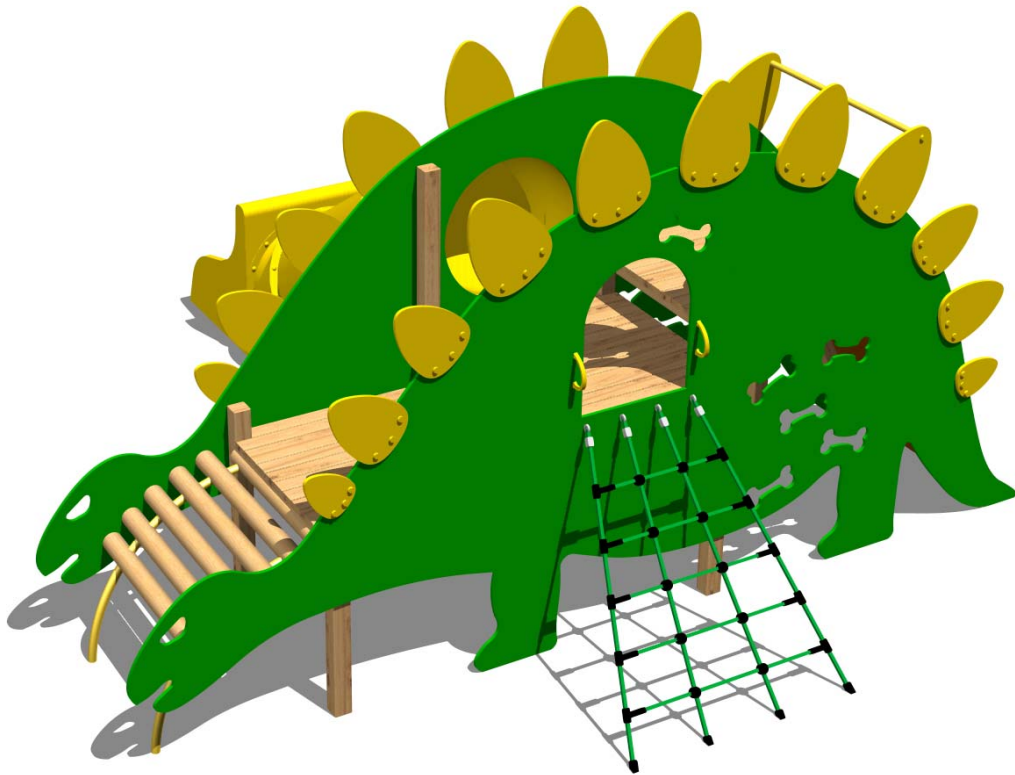

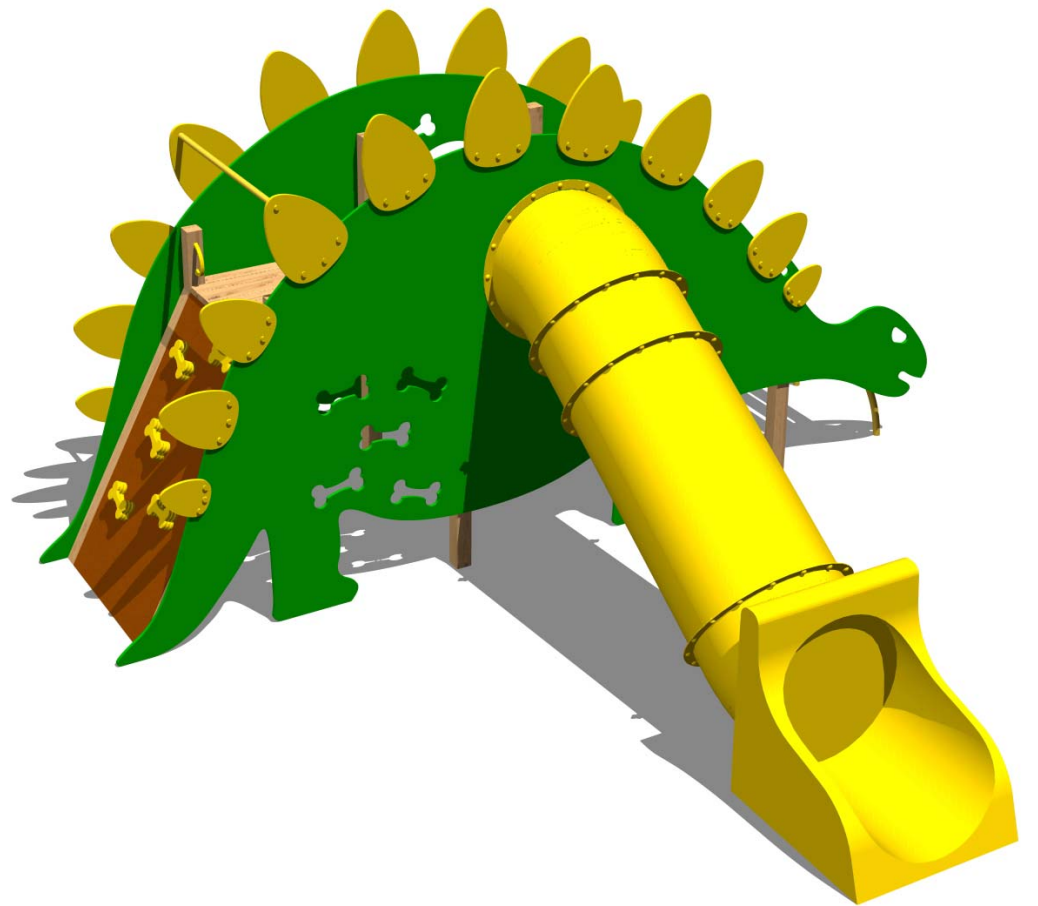
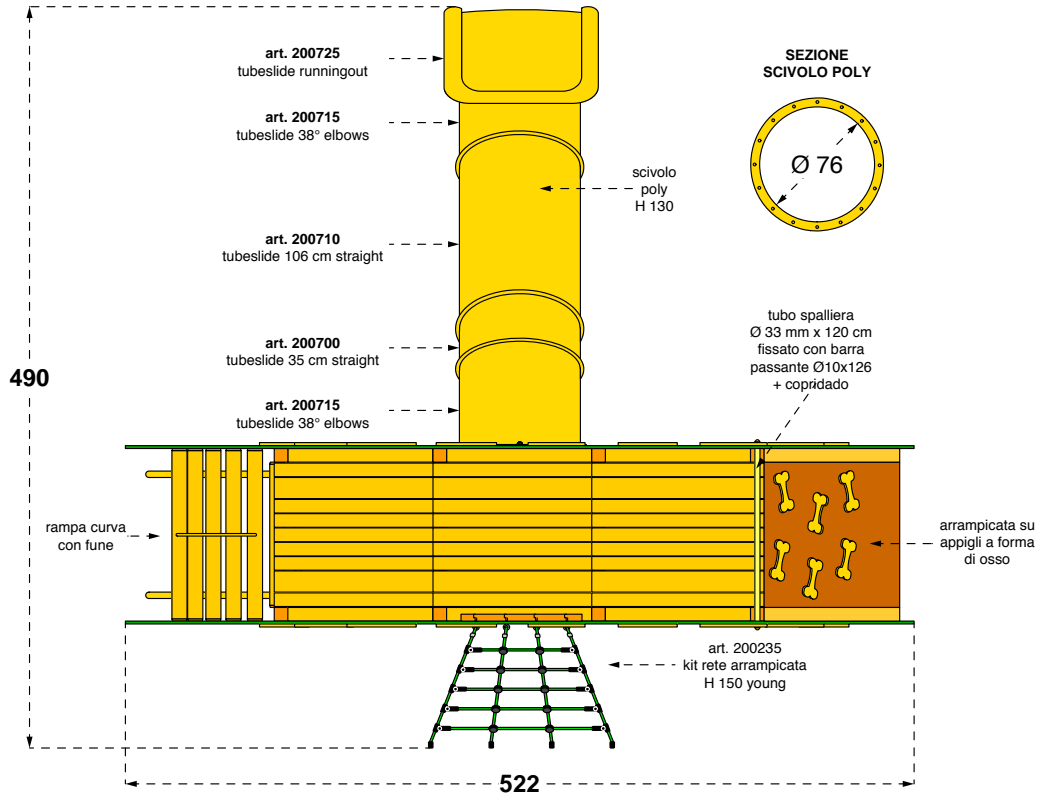
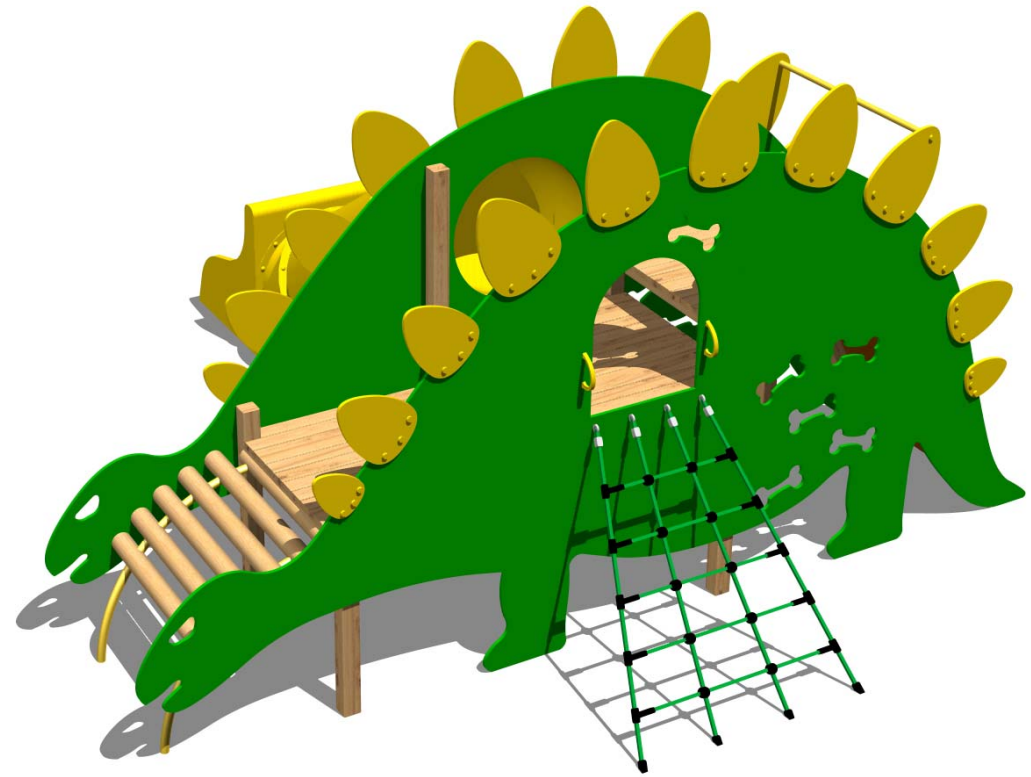
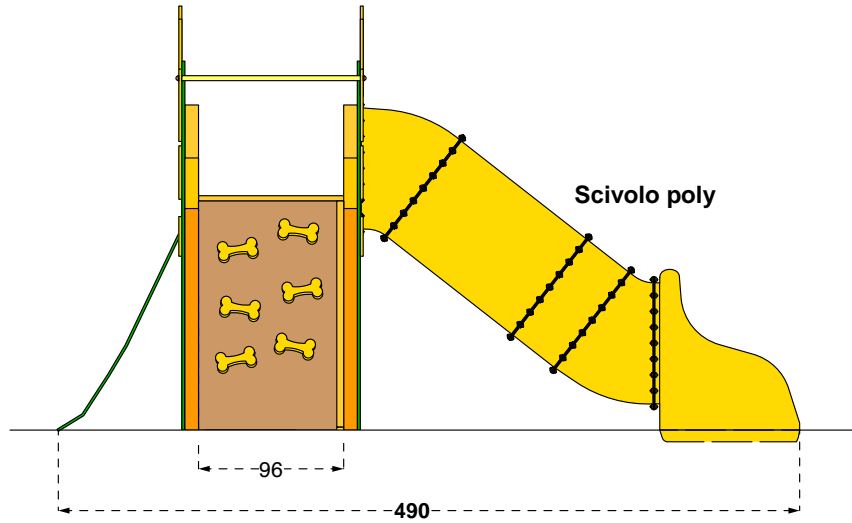

**Cod. 015048 STEGOSAURUS POLY**

LEGNOLANDIA Rev. 4

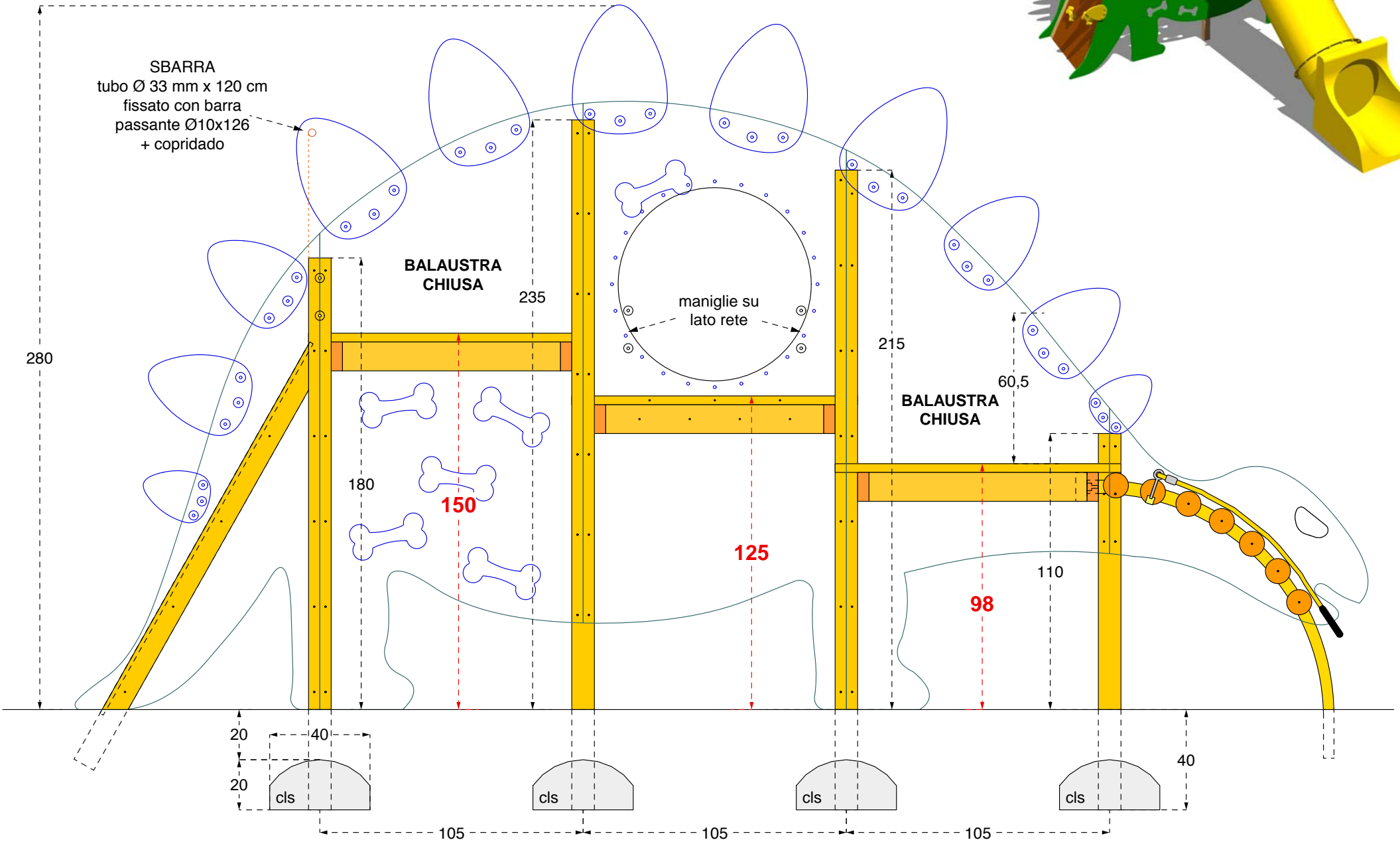
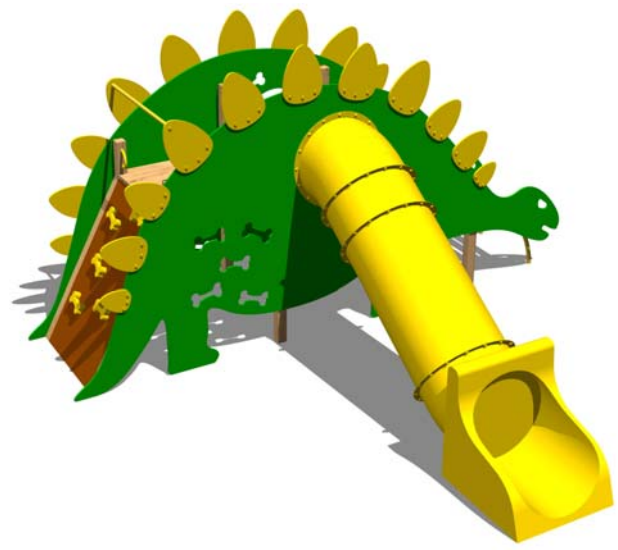



SEZIONE STRUTTURA IN LEGNO

PARTICOLARE F

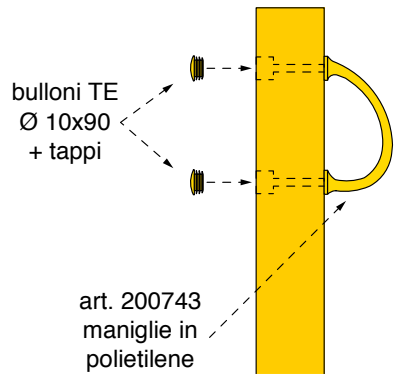

PARTICOLARE G

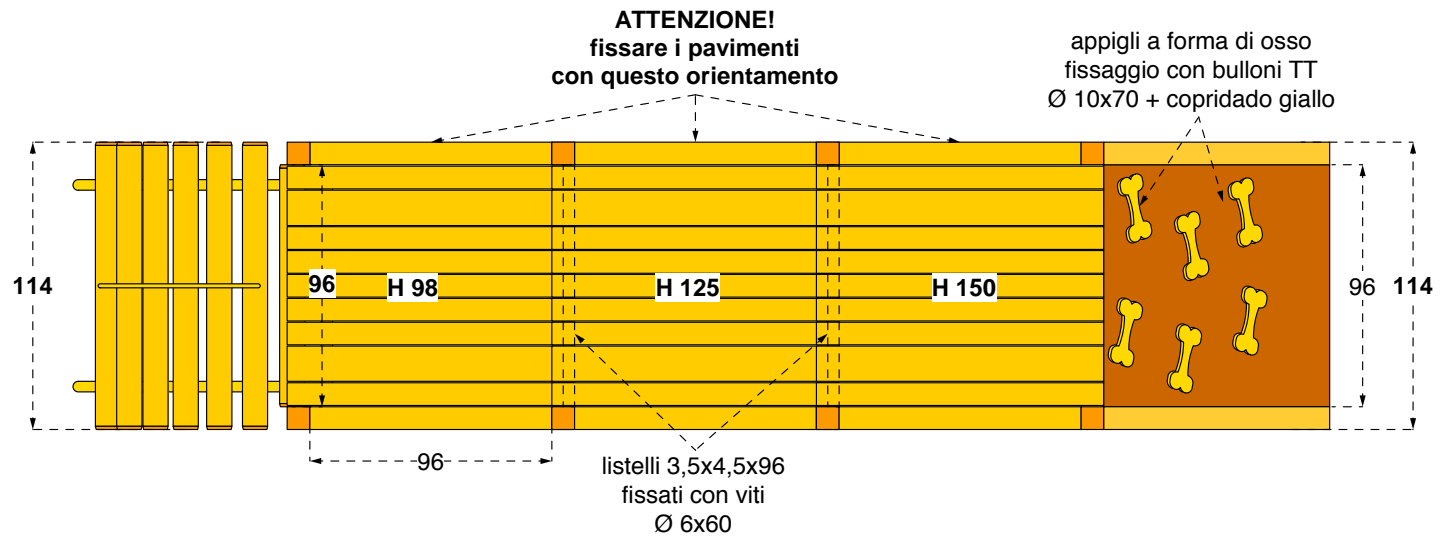
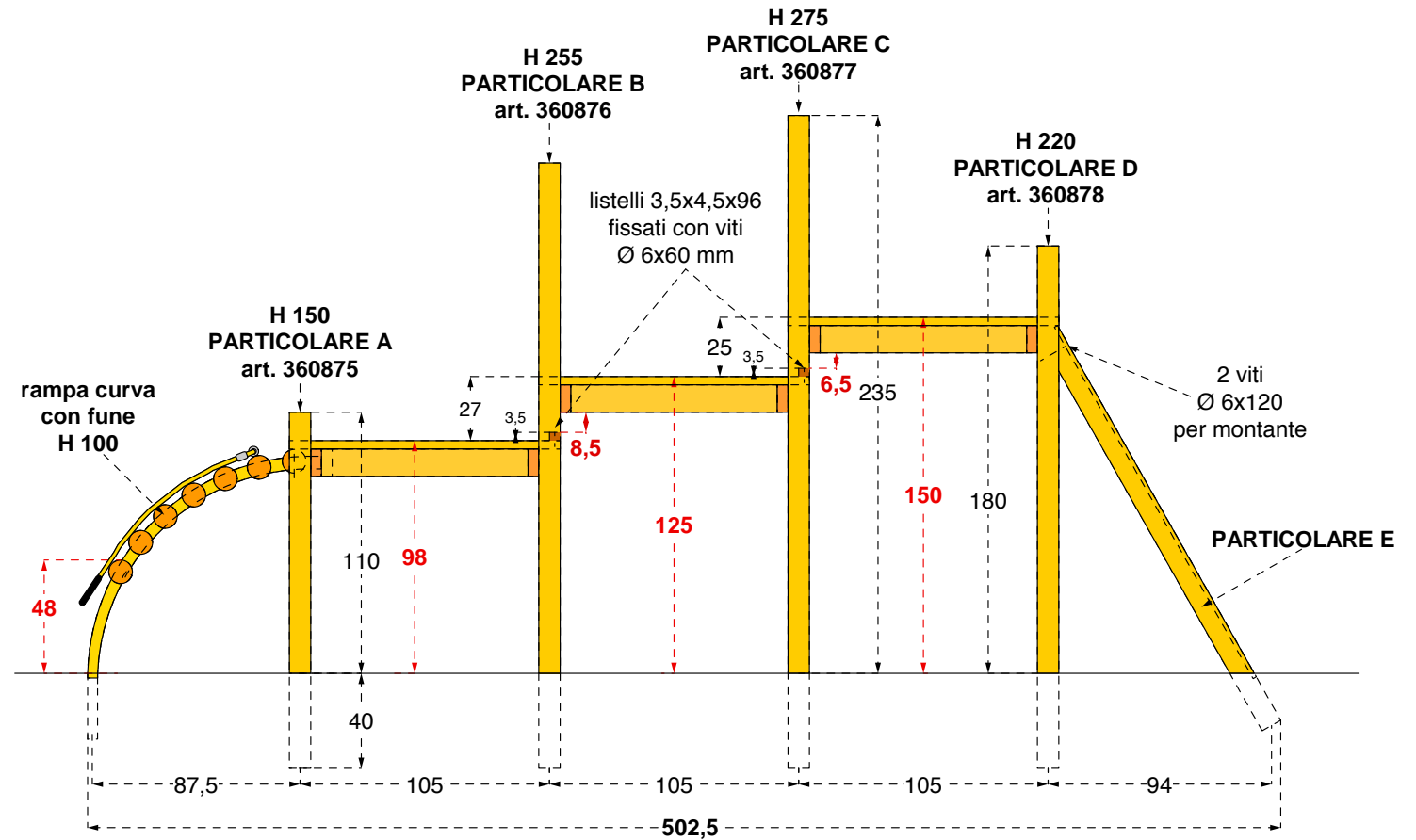
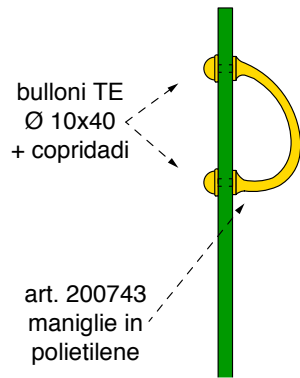

<b>BASE STEGOSAURUS</b>		
<b>Pz</b>	<b>MATERIALE e parti pre-assemblate</b>	<b>POSIZIONE</b>
2	morali 9x9x150 cm	montanti torri
2	morali 9x9x255 cm	montanti torri
2	morali 9x9x275 cm	montanti torri
2	morali 9x9x220 cm	montanti torri
2	morali 9x9x190 cm	montanti rampa con appigli
2	listelli 3,5x4,5x96 cm	pavimento torri H 100 e 125
3	Pannelli pavimento standard 114x114 cm	pavimenti ripiani
2	maniglie in polietilene	maniglie arrampicata
2	maniglie in polietilene	maniglie rete
1	pannello con appigli a forma di osso	arrampicata torretta H 150
1	rampa curva H 100	arrampicata torretta H 98
1	tubo spalliera Ø 33x120 cm	parapetto arrampicata H 150
10	sagome polietilene verde (stegosaurus)	pareti struttura
<b>Pz</b>	<b>FERRAMENTA sfusa</b>	<b>POSIZIONE</b>
24	bull. testa tonda ø 10x130 + dadi + rondelle + tappi	fissaggio pavimento alla struttura
6	viti Ø 6x60	fiss. listelli a pavimenti
2	bull. testa esagono ø 10x60 + dadi + rond. + tappi	fiss. rampa curva
2	dadi autobl. Ø 10 + copridado	fiss. tubo spalliera
12	viti Ø 6x90	fiss. pannello plywood con appigli
4	viti Ø 6x120	fiss. montanti rampa con appigli
104	viti Ø 6x90 + rondellina gialla	fiss. sagome stegosaurus a struttura
4	bulloni TE Ø 10x90 + rond. + tappi	fiss. maniglie arrampicata
4	bulloni TE Ø 10x40 + copridadi	fiss. maniglie rete
<b>KIT RETE DI ARRAMPICATA YOUNG H 150</b>		
<b>Pz</b>	<b>MATERIALE e parti pre-assemblate</b>	<b>POSIZIONE</b>
1	rete di arrampicata young H 150	rete
1	tavola 4,5x14x80 cm	fiss. rete a struttura
<b>Pz</b>	<b>FERRAMENTA sfusa</b>	<b>POSIZIONE</b>
4	dadi M10 + rondelle + tappi	fissaggio rete
2	viti Ø 6x90	fiss. tavola a struttura
<b>KIT SCIVOLO H 130 YOUNG poly</b>		
<b>Pz</b>	<b>MATERIALE e parti pre-assemblate</b>	<b>POSIZIONE</b>
1	kit scivolo poly H 130	scivolo
<b>Pz</b>	<b>FERRAMENTA sfusa</b>	<b>POSIZIONE</b>
24	bulloni testa tonda Ø 10x40 + copridadi	fiss. scivolo

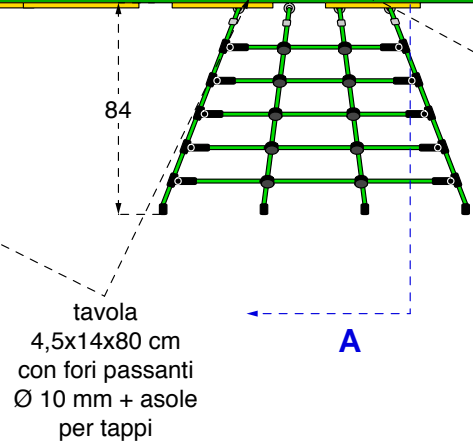
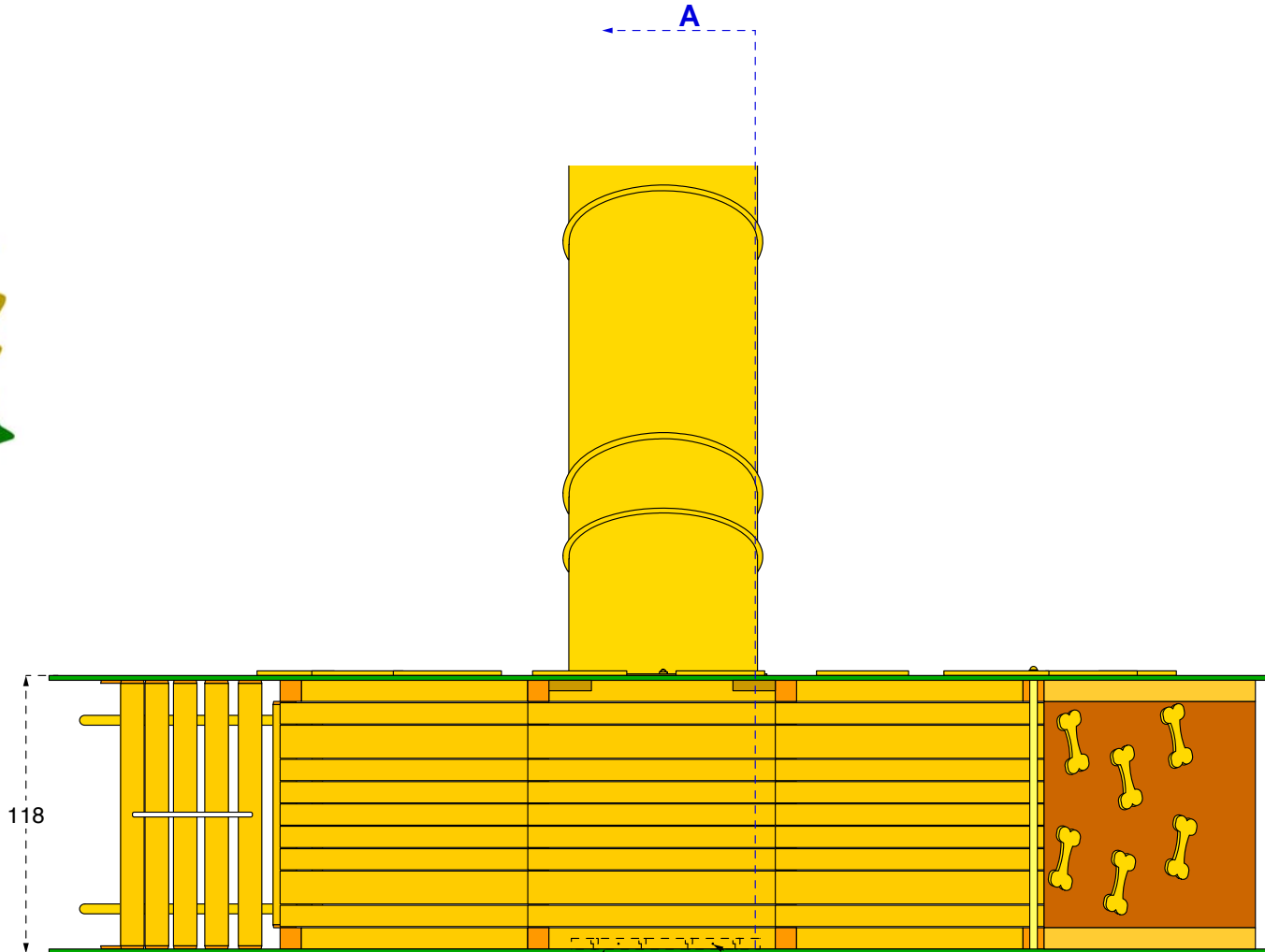
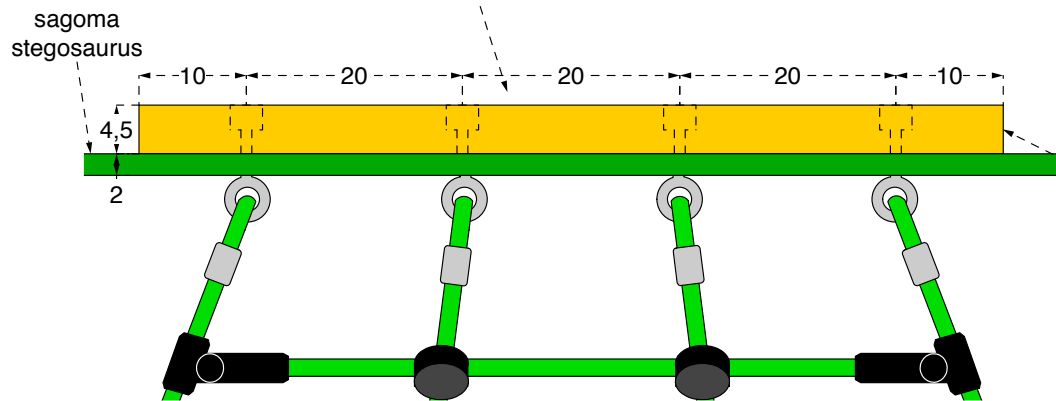
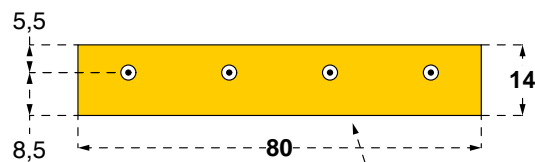
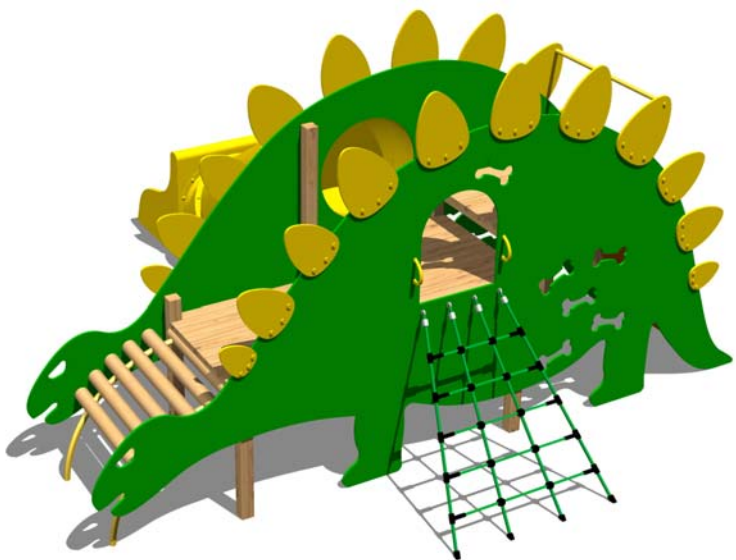

2 viti da sopra il pavimento Ø 6x90  
**VEDI FOTO**



**Cod. 015048 STEGOSAURUS POLY**

LEGNOLANDIA Rev. 4

**PARTICOLARE FISSAGGIO SQUAME**

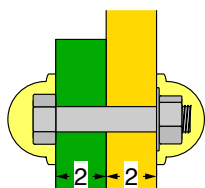

bulloni TE Ø10x60  
dado autobloccante  
+ 2 copridadi

**SEZIONE A-A**

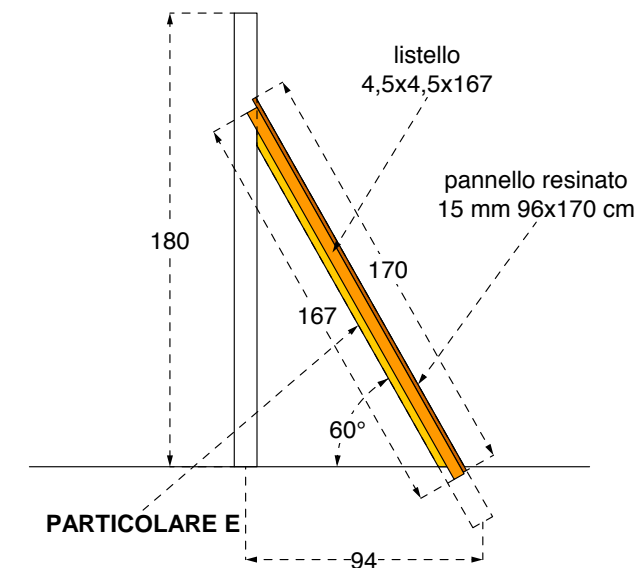
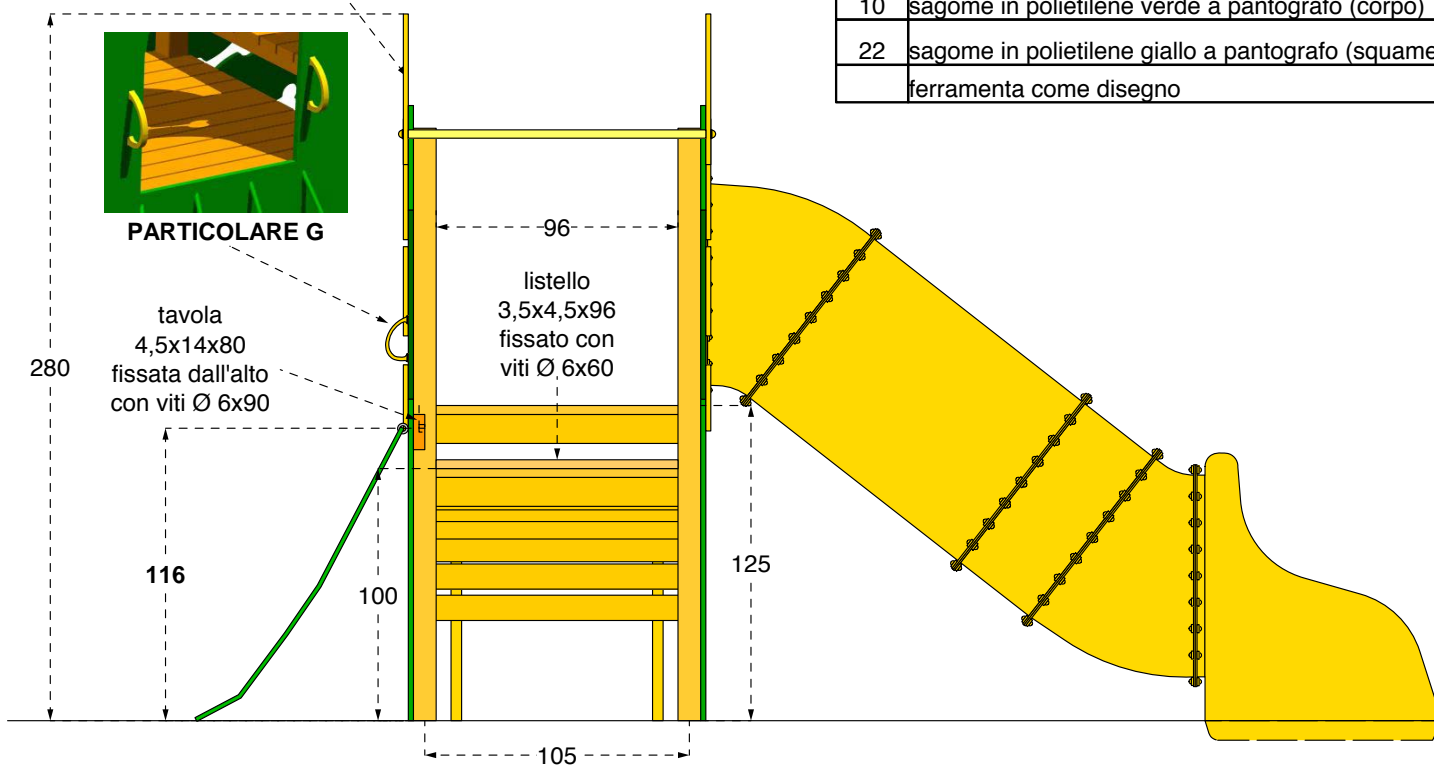

Pz.	Descriz.	Lungh.	1^Lav.	Particolare
2	morali 9x9 superwood art. 360875	150	1 ST + fori	<b>A</b>
2	morali 9x9 superwood art. 360876	255	1 ST + fori	<b>B</b>
2	morali 9x9 superwood art. 360877	275	1 ST + fori	<b>C</b>
2	morali 9x9 superwood (1 DX e 1 SX)	220	1 ST + fori	<b>D</b>
2	listelli 3,5x4,5	96		
1	tubo spalliera Ø 33	120		
3	kit pavimento torri young			
2	morali 9x9 superwood art. 360879	190	1 TA	<b>E</b>
1	pannello plywood resinato 15 mm	96 x 170		
2	listelli 4,5x4,5	167		
1	tavola 4,5x14	80	2 ST + fori	
1	kit rete d'arrampicata young H 150			
1	kit rampa curva con fune A MISURA VEDI DISEGNO			
1	scivolo H 130 poly			
6	pioli in polietilene giallo per arrampicata a forma di osso		PAN	
4	art. 200743 maniglie in polietilene			<b>F - G</b>
10	sagome in polietilene verde a pantografo (corpo)		PAN	
22	sagome in polietilene giallo a pantografo (squame)		PAN	
	ferramenta come disegno			

## PARTICOLARI RAMPA per STEGOSAURUS

Pz.	Descriz.	Lungh.	1^Lav.	Particolare
6	pali Ø 9 fuori cuore art. 360880	114	2 SV + fori	
1	palo Ø 9 fuori cuore art. 360881	96	2 SV + fori	
2	tubi rampa curva H 100 art. 200421		TAGLIARE	
1	art. 200507 fune h 100 young	250		
1	tavola 4,5x11,5	96	fori	<b>H</b>
	ferramenta come disegno			

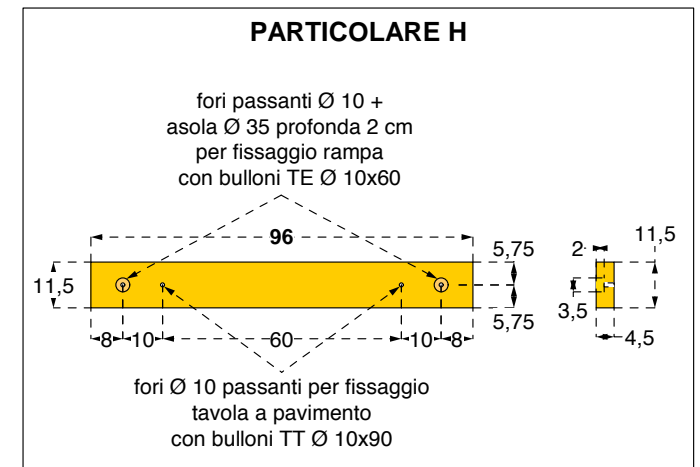
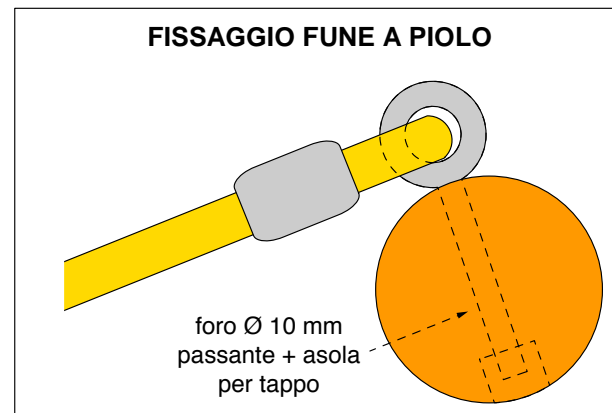
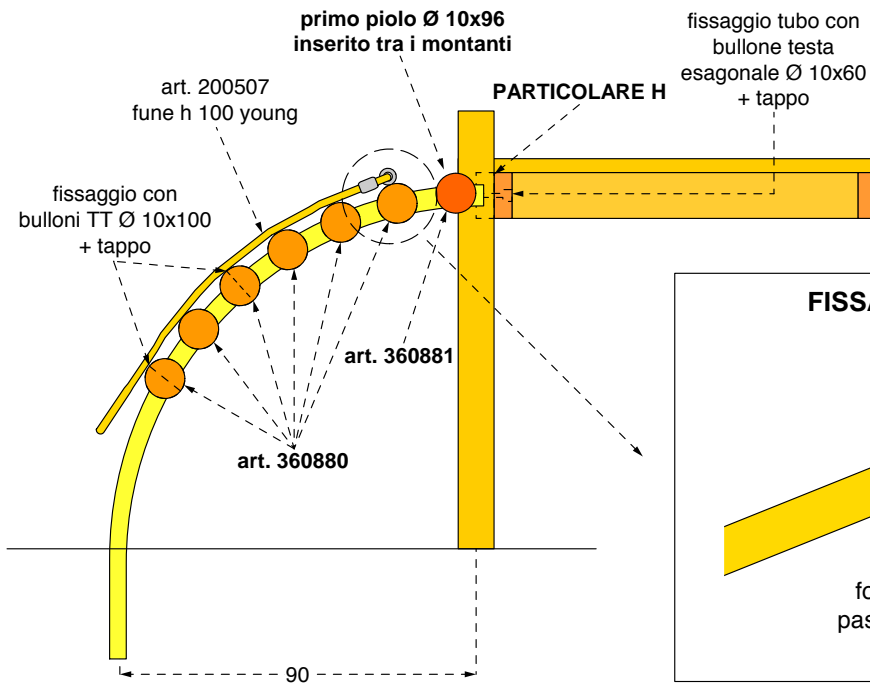
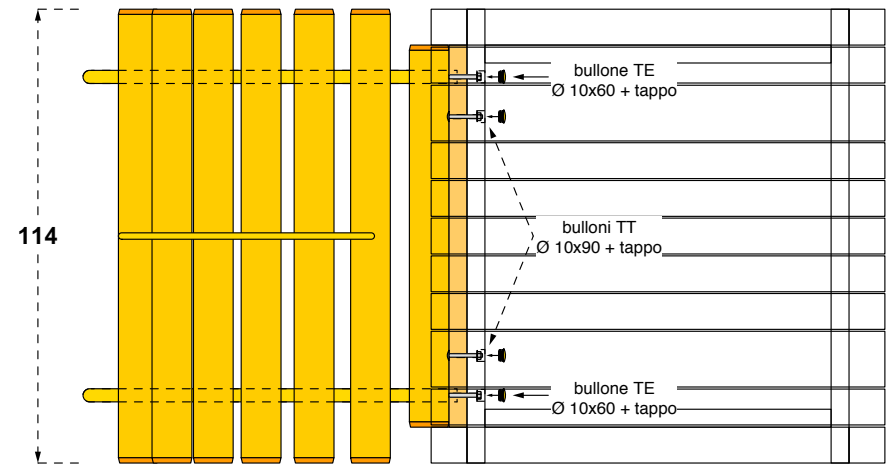
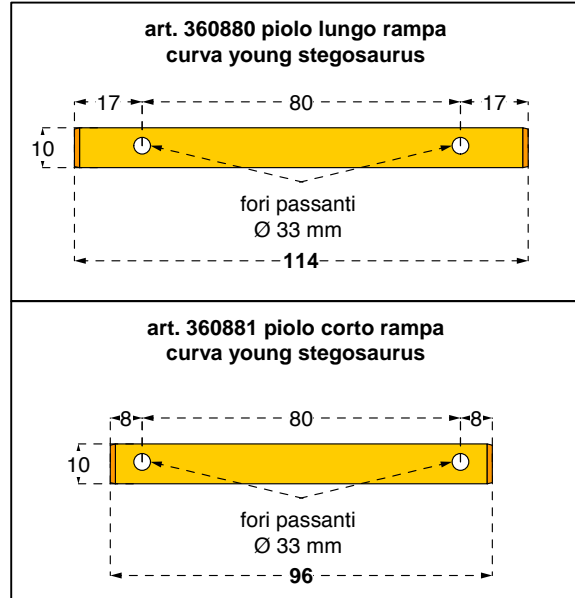

DISPOSIZIONE dei 6 APPIGLI

