

Cod. 015046 STEGOSAURUS
LEGNOLANDIA Rev. 3

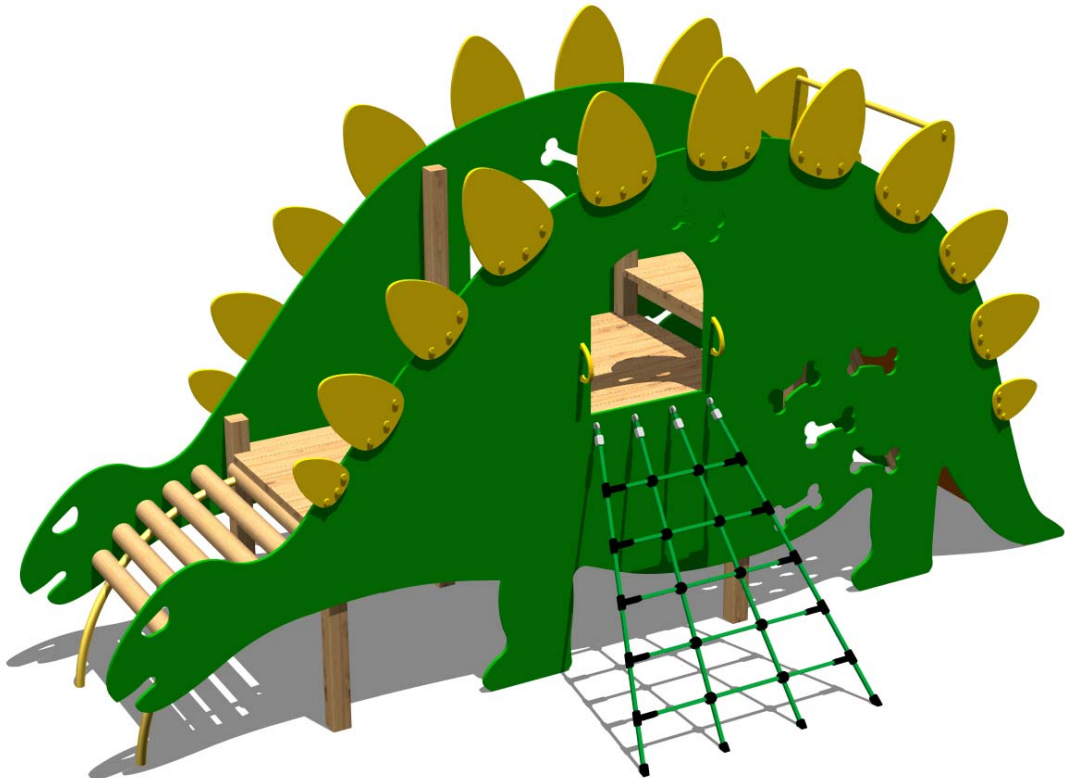

Cod. 015046 STEGOSAURUS

LEGNOLANDIA Rev. 3

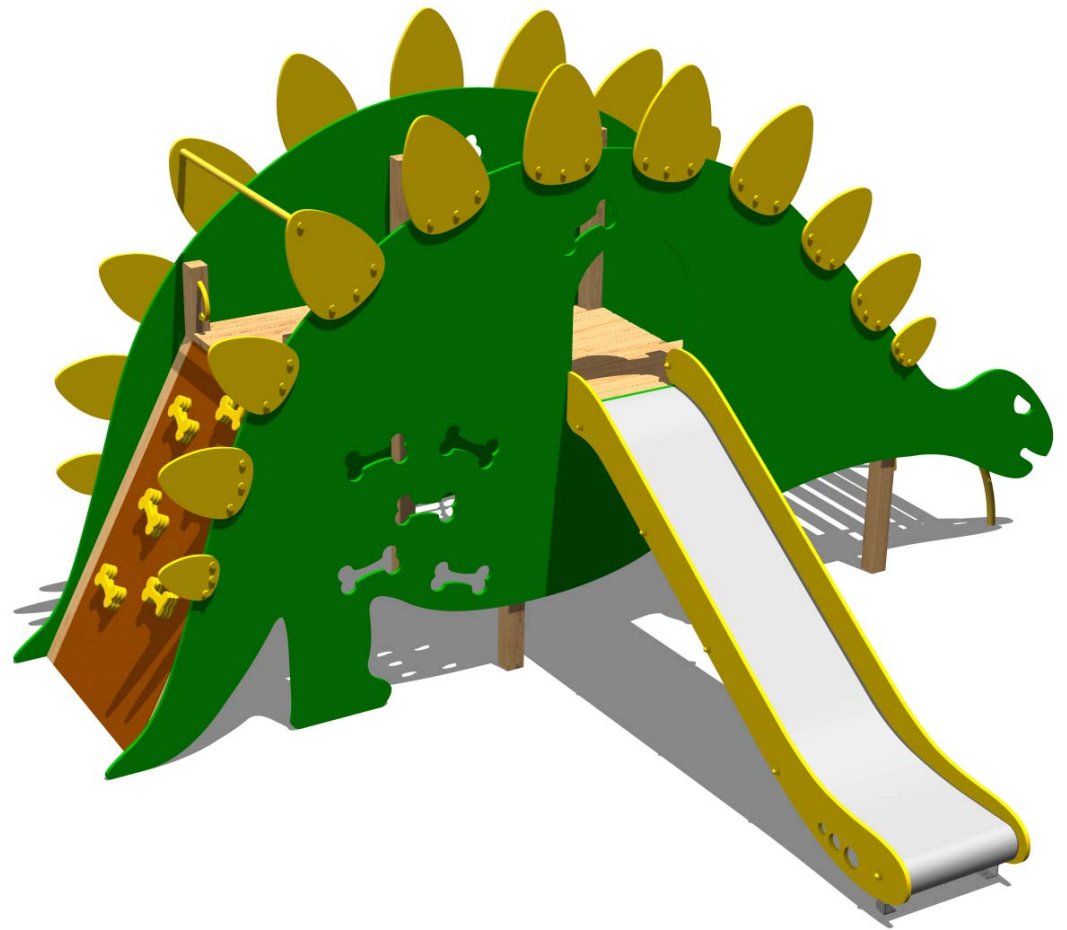
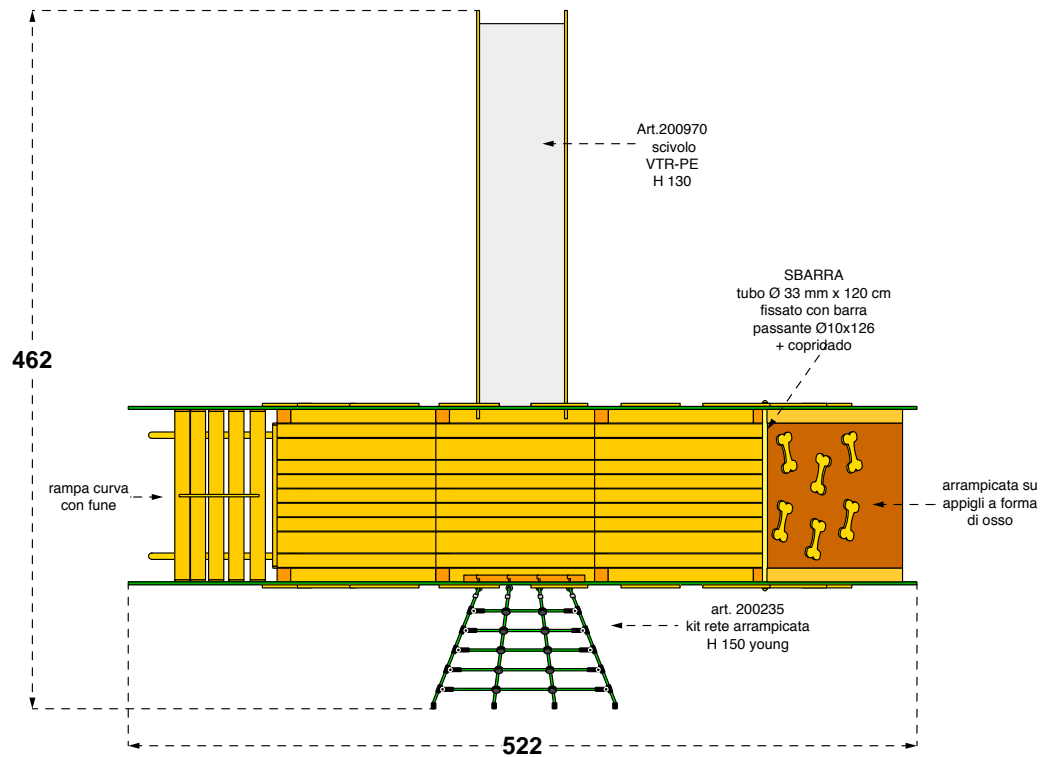
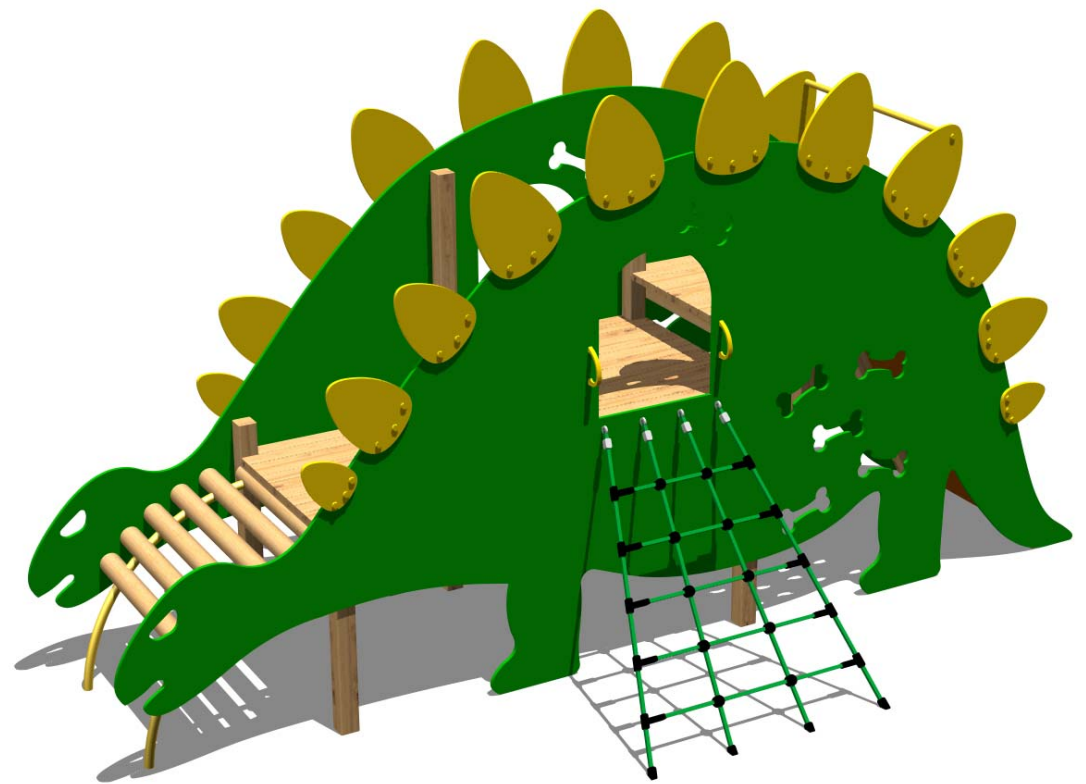
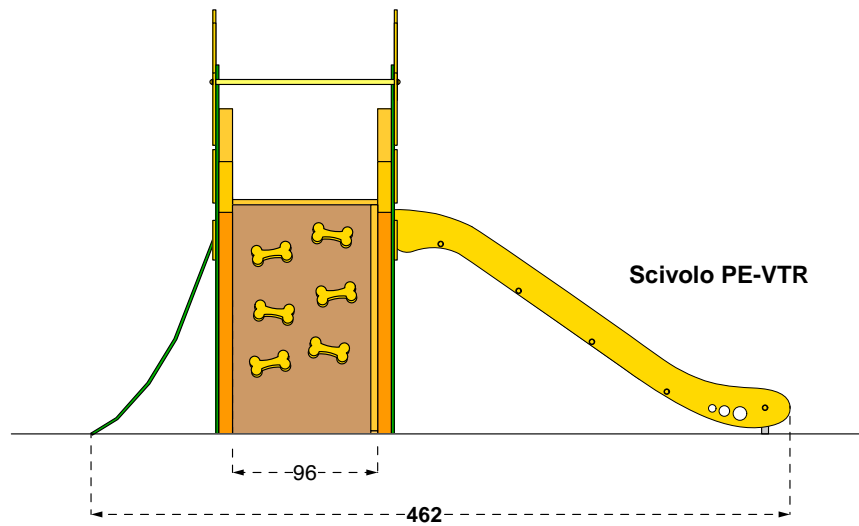

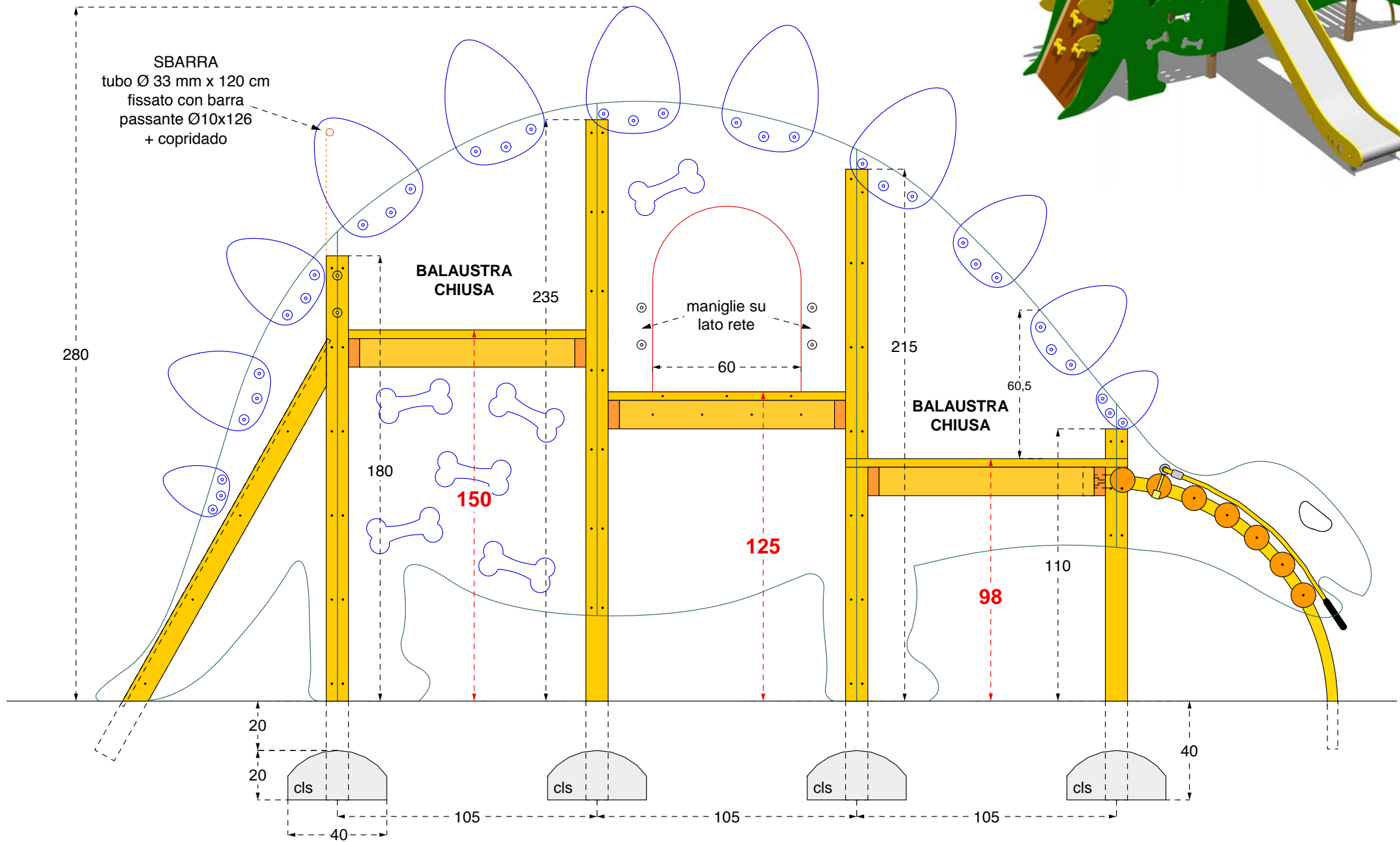
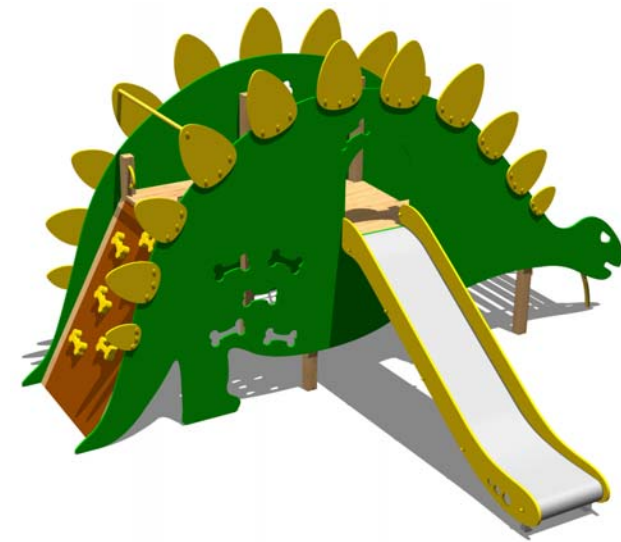

Cod. 015046 STEGOSAURUS

LEGNOLANDIA Rev. 3

DATI DI SICUREZZA / SAFETY DATA**EN 1176 - EN 1177**

art. 015046

ALTEZZA DI CADUTA LIBERA max (HIC) / FALL HEIGHT (HIC) **150 cm**

SPAZIO DI CADUTA / FALL SPACE 43,5 mq

PAVIMENTAZIONE IN PIASTRE ELASTICHE / ELASTIC TILES PAVEMENT 51,5 mq

ETA' USO CONSIGLIATA / RECOMMENDED AGE da 3 a 11 anni

Per la manutenzione consultare l'apposita scheda fornita col gioco

For maintenance see instructions supplied with the game

**PAVIMENTAZIONI DI SICUREZZA
SAFETY PAVEMENT**

Su tutte le attrezzature per aree da gioco con un'altezza di caduta libera superiore a 60 cm bisogna prevedere il rivestimento dello spazio di caduta con una superficie ammortizzante.

On all playground equipment with a free fall height superior to 60 cm a surface cushioning has to be provided which covers the fall area.

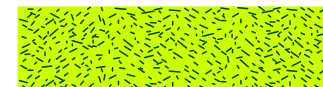

PRATO e TERRICCIO /
LAWN and GROUND
Altezza di caduta /
Fall height < o = 100 cm



CORTECCIA pezzatura /
BARK size 20-80 mm
TRUCIOLI pezzatura /
CHIPS size 5-30 mm
Spessore minimo /
Thickness 30 cm
Altezza di caduta fino a /
Fall Height up to 300 cm



SABBIA pezzatura /
SAND size 0,2-2 mm
GHIAIA pezzatura /
GRAVEL size 2-8 mm
Spessore minimo /
Thickness 30 cm
Altezza di caduta fino a /
Fall Height up to 300 cm

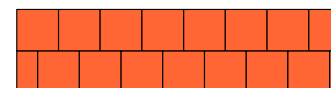

PIASTRE ELASTICHE /
ELASTIC TILES

PAVIMENTAZIONE
IN PIASTRE ELASTICHE /
ELASTIC TILES PAVEMENT

SPAZIO DI CADUTA /
FALL SPACE

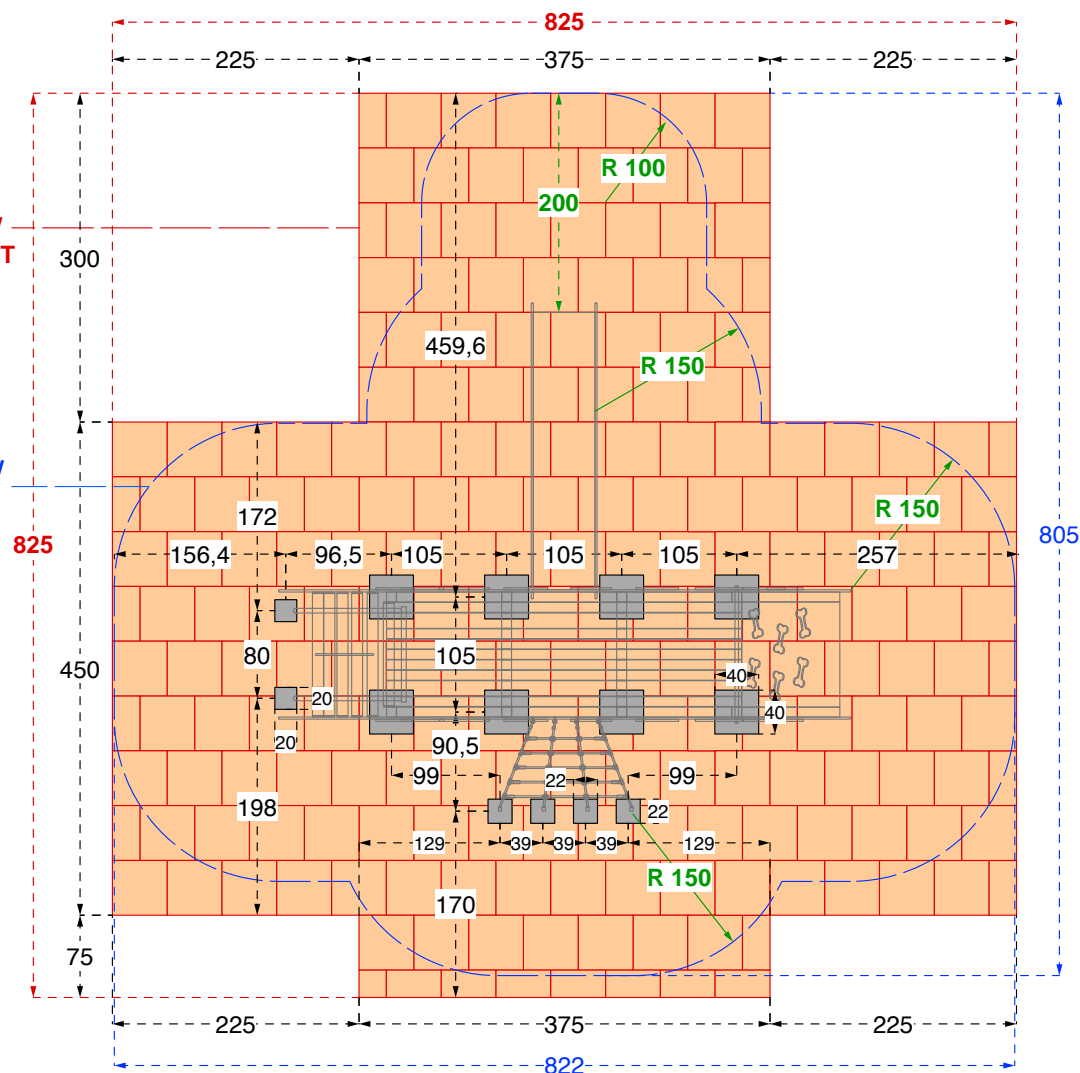

SEZIONE STRUTTURA IN LEGNO

PARTICOLARE F

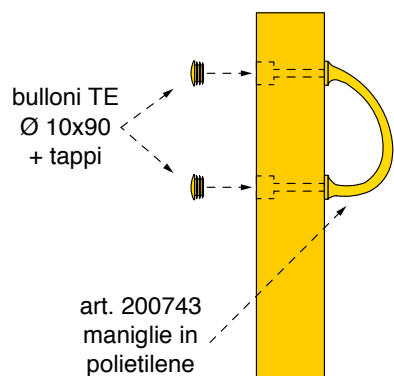

PARTICOLARE G

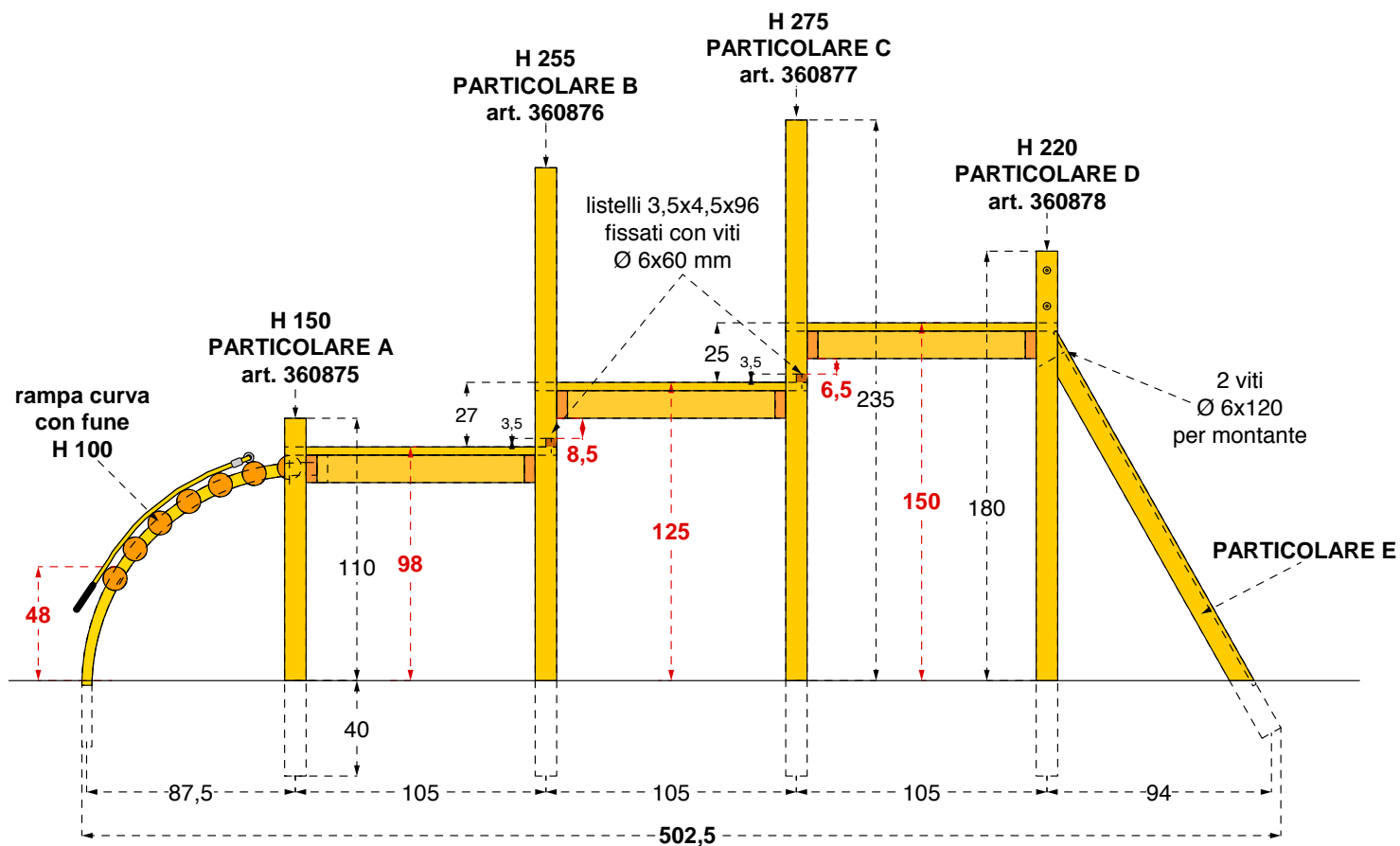
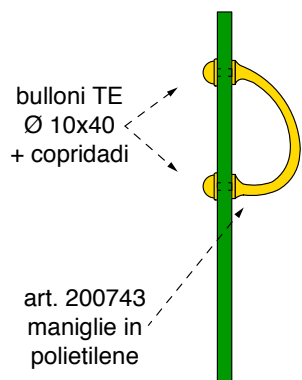

ATTENZIONE!
fissare i pavimenti
con questo orientamento

appigli a forma di osso
fissaggio con bulloni TT
Ø 10x70 + copridado giallo

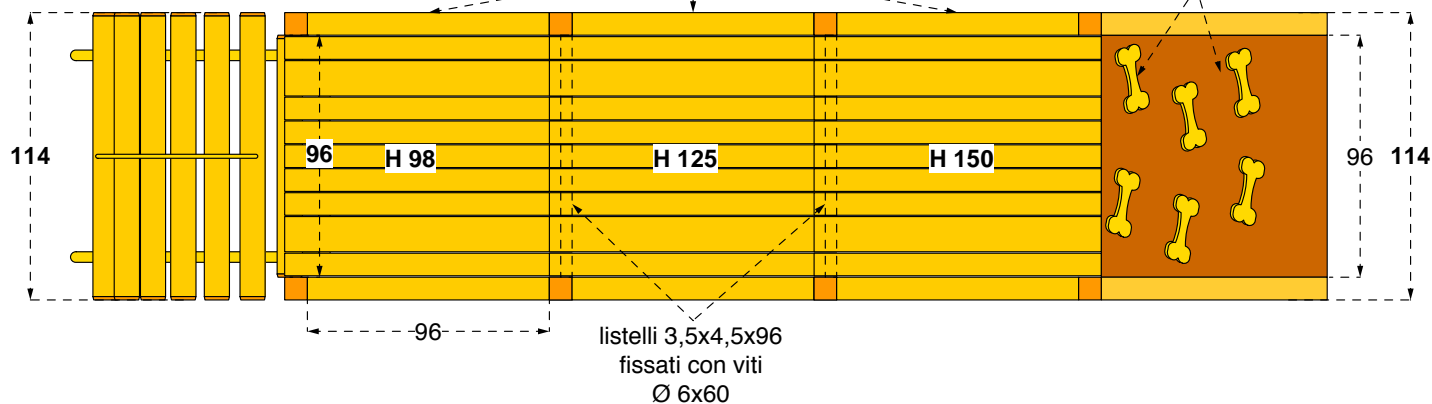

BASE STEGOSAURUS		
Pz	MATERIALE e parti pre-assemblate	POSIZIONE
2	morali 9x9x150 cm	montanti torri
2	morali 9x9x255 cm	montanti torri
2	morali 9x9x275 cm	montanti torri
2	morali 9x9x220 cm	montanti torri
2	morali 9x9x190 cm	montanti rampa con appigli
2	listelli 3,5x4,5x96 cm	pavimento torri H 100 e 125
3	Pannelli pavimento standard 114x114 cm	pavimenti ripiani
2	maniglie in polietilene	maniglie arrampicata
2	maniglie in polietilene	maniglie rete
1	pannello con appigli a forma di osso	arrampicata torretta H 150
1	rampa curva H 100	arrampicata torretta H 98
1	tubo spalliera Ø 33x120 cm	parapetto arrampicata H 150
10	sagome polietilene verde (stegosaurus)	pareti struttura
Pz	FERRAMENTA sfusa	POSIZIONE
24	bull. testa tonda ø 10x130 + dadi + rondelle + tappi	fissaggio pavimento alla struttura
6	viti Ø 6x60	fiss. listelli a pavimenti
2	bull. testa esagono ø 10x60 + dadi + rond. + tappi	fiss. rampa curva
2	dadi autobl. Ø 10 + copridado	fiss. tubo spalliera
12	viti Ø 6x90	fiss. pannello plywood con appigli
4	viti Ø 6x120	fiss. montanti rampa con appigli
104	viti Ø 6x90 + rondellina gialla	fiss. sagome stegosaurus a struttura
4	bulloni TE Ø 10x90 + rond. + tappi	fiss. maniglie arrampicata
4	bulloni TE Ø 10x40 + copridadi	fiss. maniglie rete
KIT RETE DI ARRAMPICATA YOUNG H 150		
Pz	MATERIALE e parti pre-assemblate	POSIZIONE
1	rete di arrampicata young H 150	rete
1	tavola 4,5x14x80 cm	fiss. rete a struttura
Pz	FERRAMENTA sfusa	POSIZIONE
4	dadi M10 + rondelle + tappi	fissaggio rete
2	viti Ø 6x90	fiss. tavola a struttura
KIT SCIVOLO		
Pz	MATERIALE e parti pre-assemblate	POSIZIONE
1	scivolo in VTR - PE	
Pz	FERRAMENTA sfusa	POSIZIONE
2	staffe gialle + 2 listelli 4,5x4,5x18 cm PART. I	fissaggio scivolo alla struttura

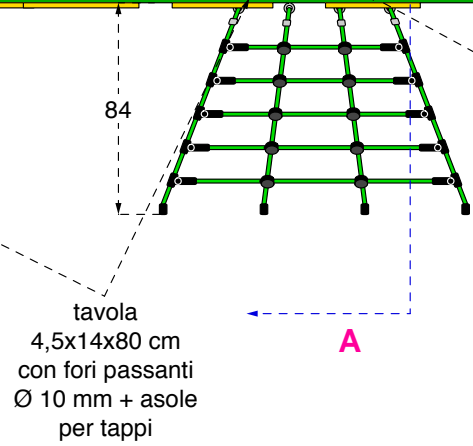
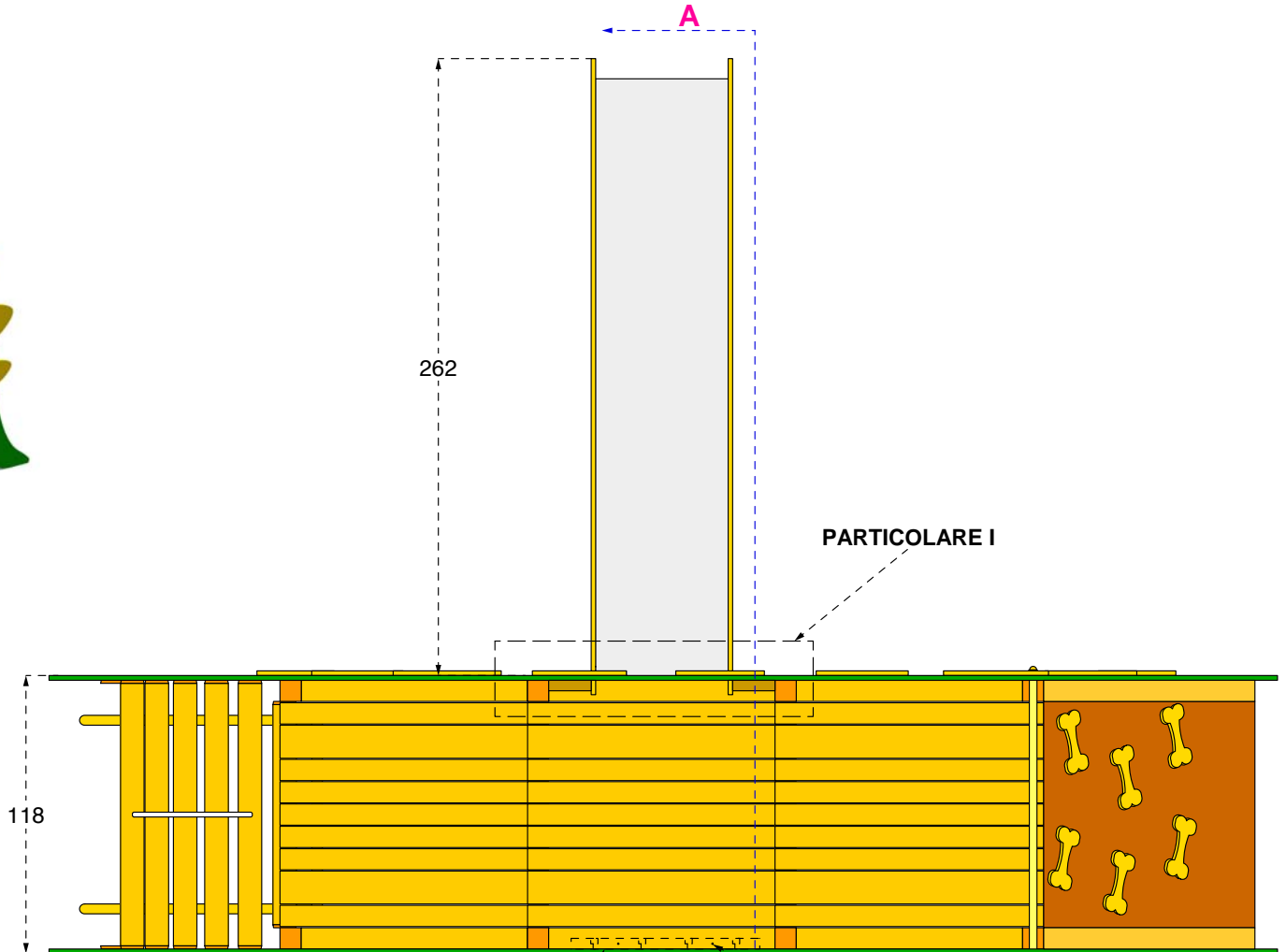
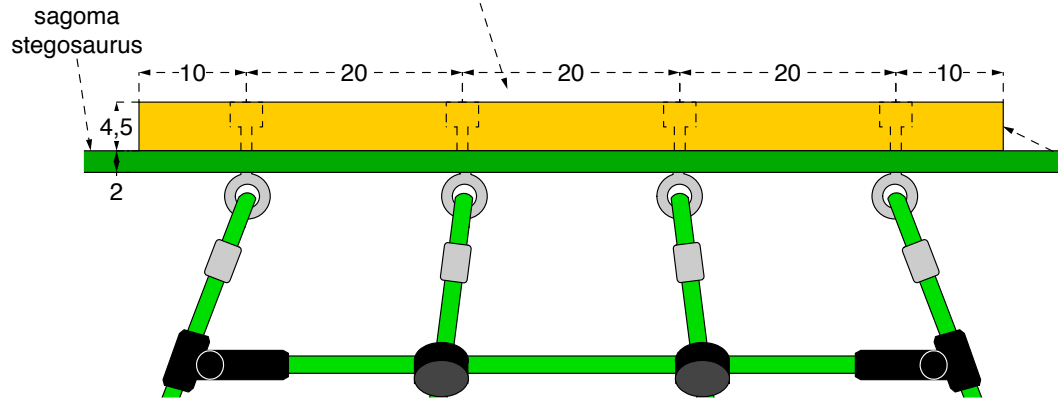
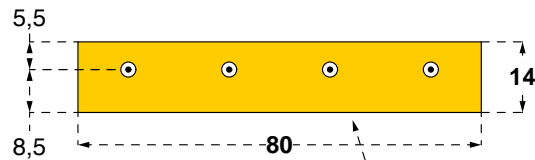
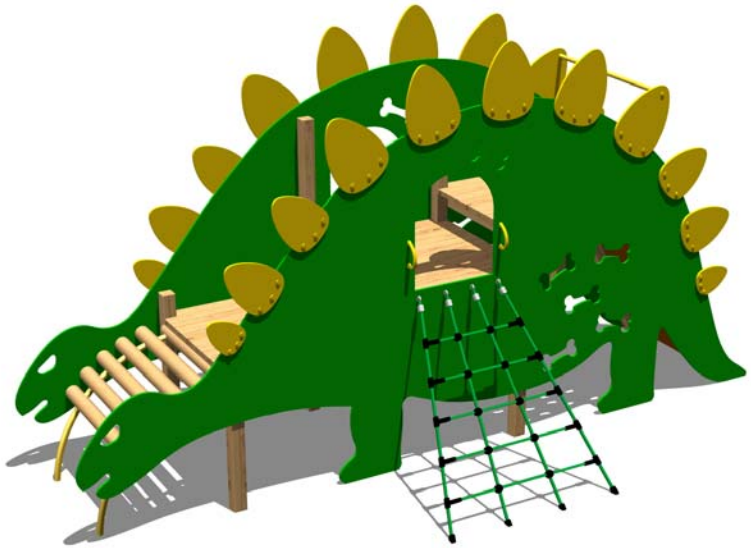

2 viti da sopra
il pavimento
Ø 6x90
VEDI FOTO



Cod. 015046 STEGOSAURUS

LEGNOLANDIA Rev. 3

**PARTICOLARE FISSAGGIO
SQUAME**

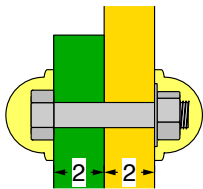

bulloni TE Ø10x60
dado autobloccante
+ 2 copridadi

SEZIONE A-A

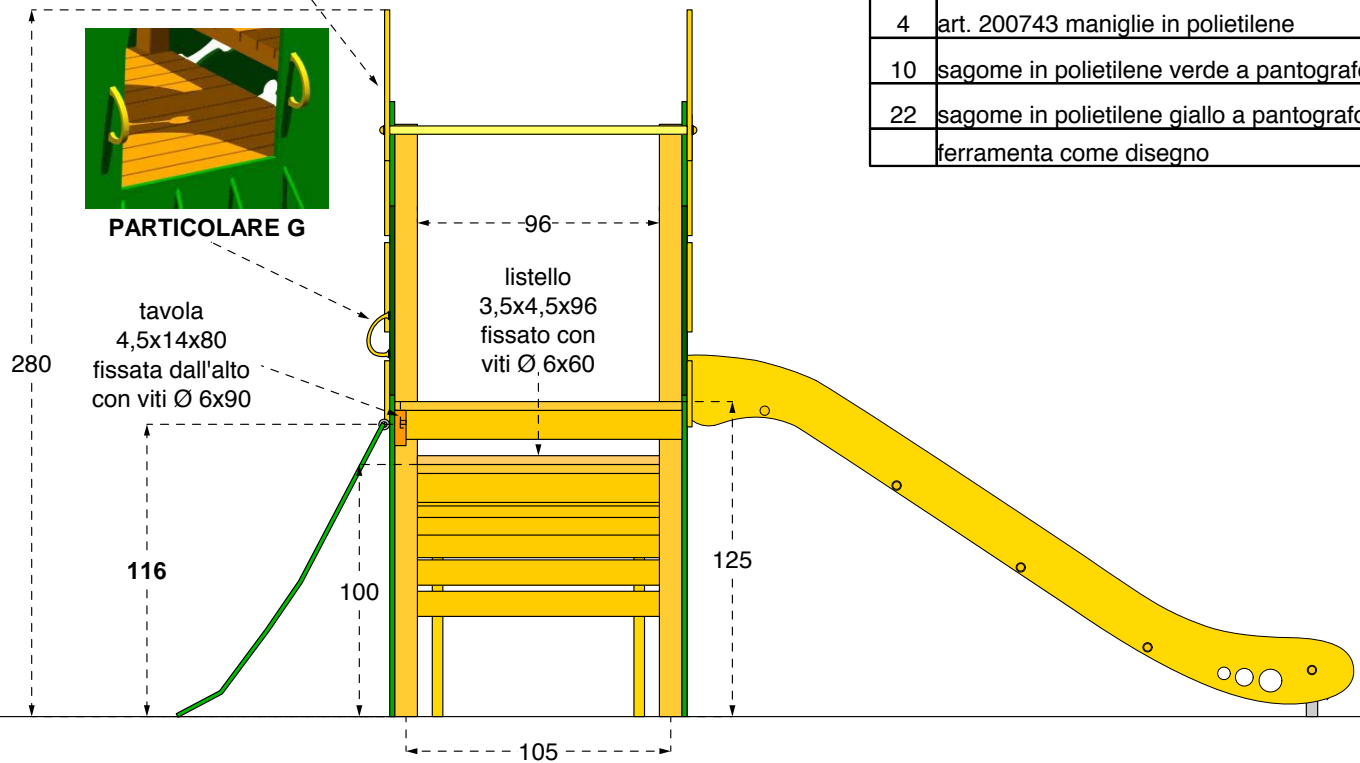

PARTICOLARE G

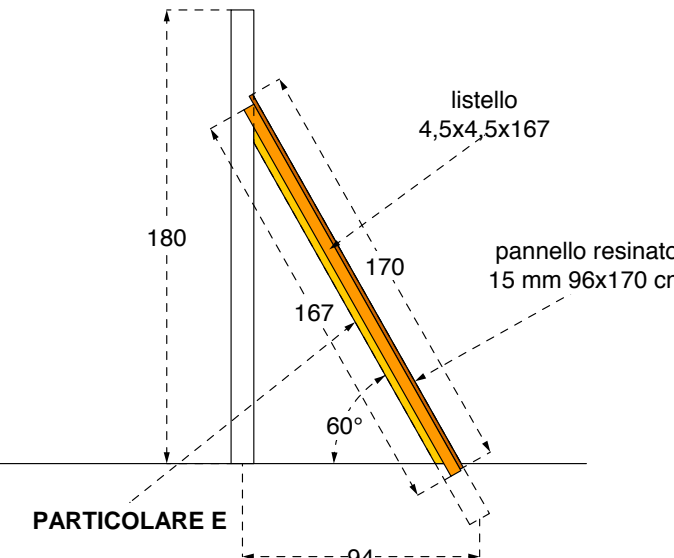

Pz.	Descriz.	Lungh.	1^Lav.	Particolare
2	morali 9x9 superwood art. 360875	150	1 ST + fori	A
2	morali 9x9 superwood art. 360876	255	1 ST + fori	B
2	morali 9x9 superwood art. 360877	275	1 ST + fori	C
2	morali 9x9 superwood (1 DX e 1 SX) art. 360878-360882	220	1 ST + fori	D
2	listelli 3,5x4,5	96		
2	listelli 4,5x4,5 + staffe a "L" nylon gialle	18		I
1	tubo spalliera Ø 33	120		
3	kit pavimento torri young			
2	morali 9x9 superwood art. 360879	190	1 TA	E
1	pannello plywood resinato 15 mm	96 x 170		
2	listelli 4,5x4,5	167		
1	tavola 4,5x14	80	2 ST + fori	
1	kit rete d'arrampicata young H 150			
1	kit rampa curva con fune A MISURA VEDI DISEGNO			
1	scivolo H 130 PE + VTR			
6	pioli in polietilene giallo per arrampicata a forma di osso		PAN	
4	art. 200743 maniglie in polietilene			F - G
10	sagome in polietilene verde a pantografo (corpo)		PAN	
22	sagome in polietilene giallo a pantografo (squamae)		PAN	
	ferramenta come disegno			

Cod. 015046 STEGOSAURUS

LEGNOLANDIA Rev. 3

PARTICOLARI RAMPA per STEGOSAURUS

Pz.	Descriz.	Lungh.	1^Lav.	Particolare
6	pali Ø 9 fuori cuore art. 360880	114	2 SV + fori	
1	palo Ø 9 fuori cuore art. 360881	96	2 SV + fori	
2	tubi rampa curva H 100 art. 200421		TAGLIARE	
1	art. 200507 fune h 100 young	250		
1	tavola 4,5x11,5	96	fori	H
	ferramenta come disegno			

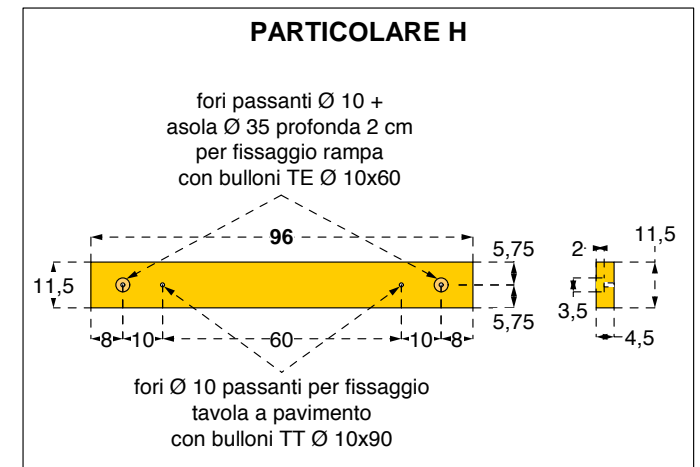
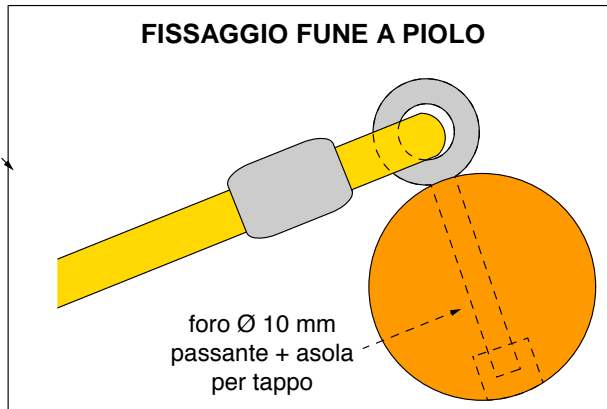
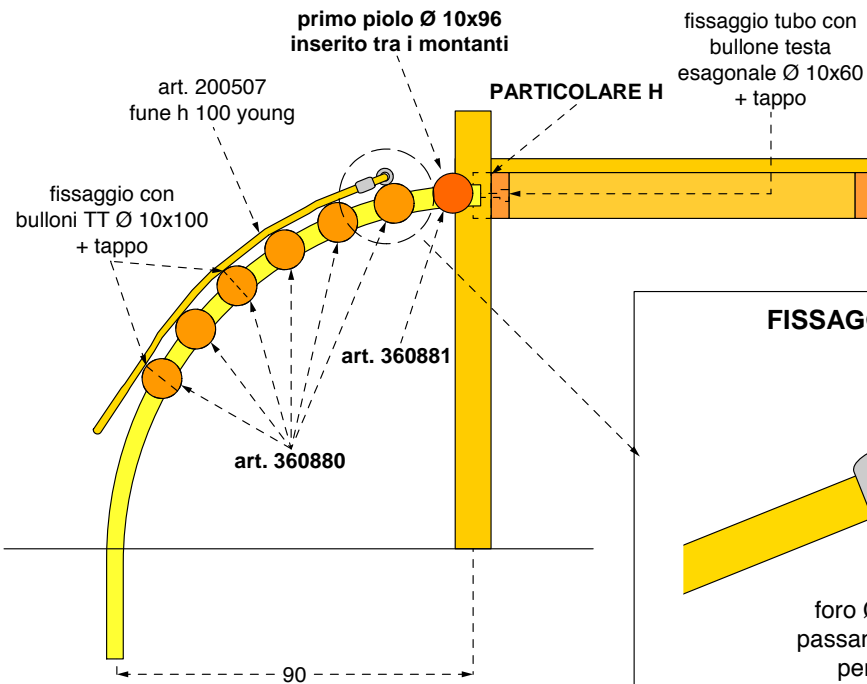
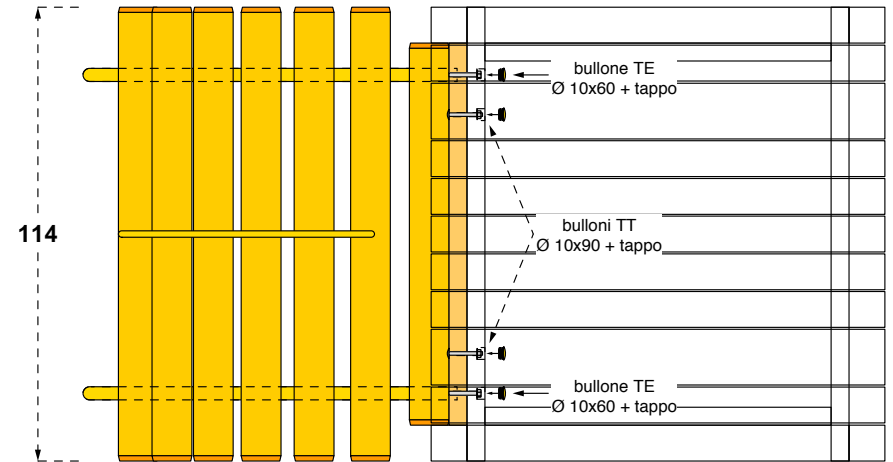
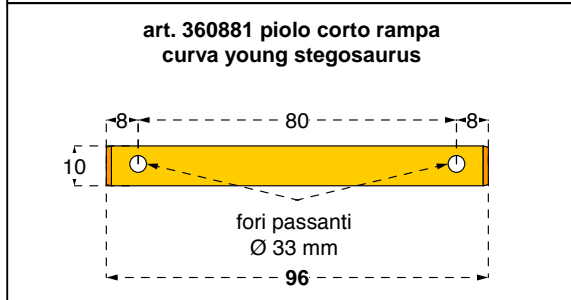
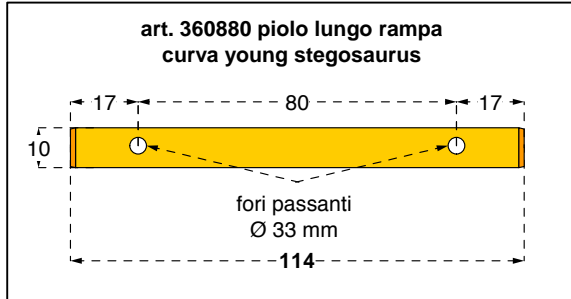

DISPOSIZIONE dei 6 APPIGLI

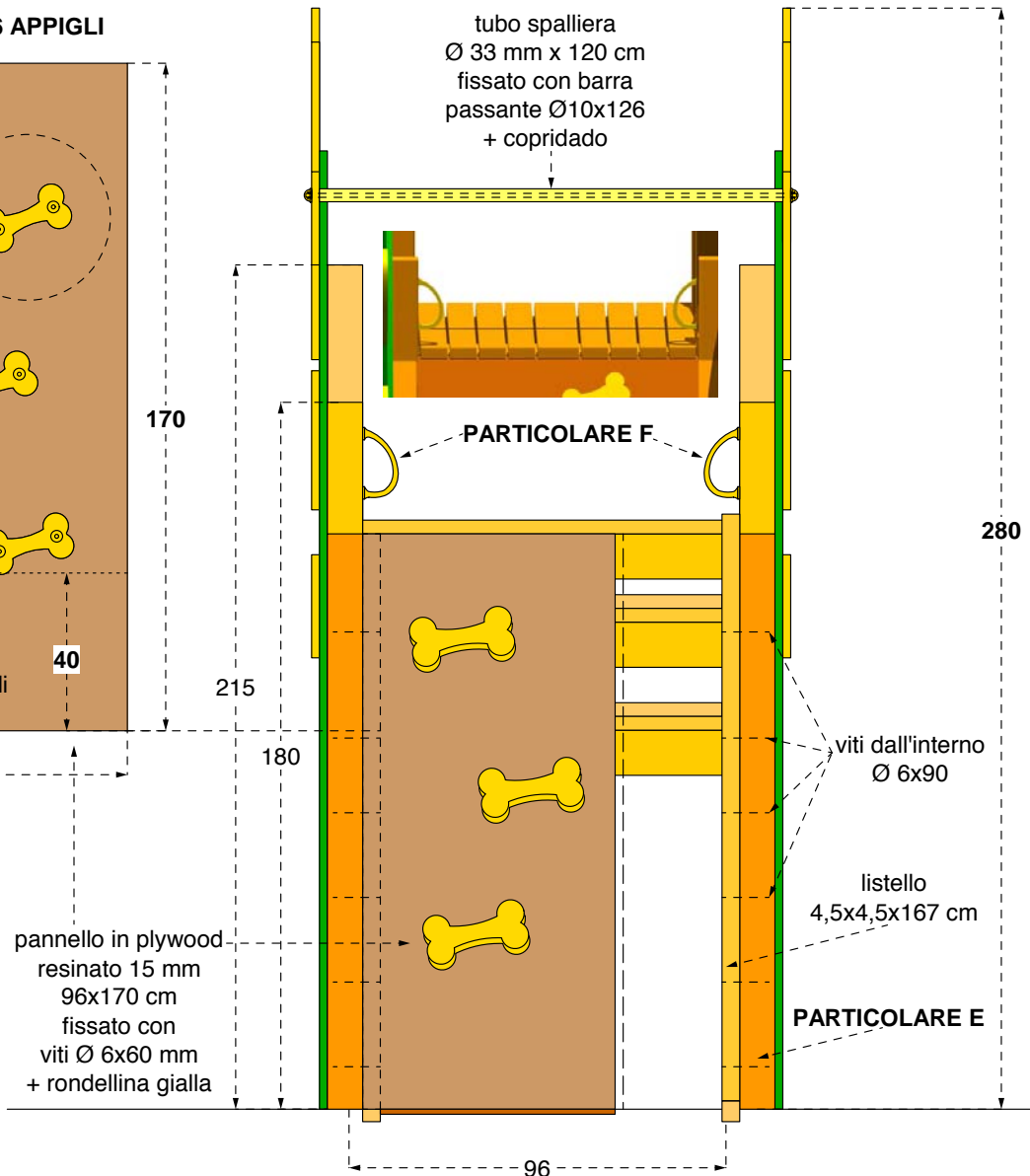
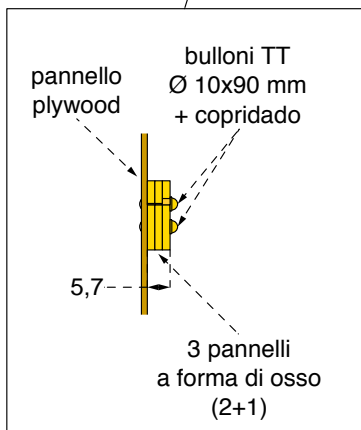
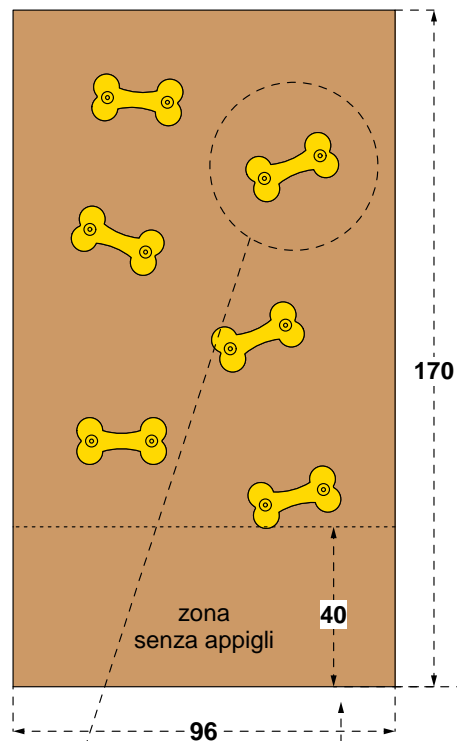

PARTICOLARE I

elemento anti-intrappolamento su uscita scivolo

